



# **Pikes Peak V2**

# **Longs Peak**

---

User Manual R2.3

# Table of Contents

1

## 1. [Introduction](#)

- 1.1. [Warranty](#)
- 1.2. [What's Included](#)
- 1.3. [Technical Specifications](#)
- 1.4. [Disclaimers & Safety Precautions](#)
- 1.5. [Uncrating Your Press](#)

## 2. [Press Setup](#)

- 2.1. [Vertical Orientation Setup](#)
- 2.2. [Horizontal Orientation Setup](#)
- 2.3. [Vertical Dual Pressure Installation](#)
- 2.4. [Horizontal Dual Pressure Installation](#)
- 2.5. [Automated Pressure Control Installation](#)
- 2.6. [Using Push Connect Fittings](#)
- 2.7. [Electrical Power](#)
- 2.8. [Compressed Air](#)

## 3. [Rosin Extraction Basics](#)

- 3.1. [Tips & Tricks](#)
- 3.2. [Yield and Material Types](#)
- 3.3. [Choosing Your Material](#)
- 3.4. [Filter Bag Preparation](#)

## 4. [Pressware Controls](#)

- 4.1. [Home Screen](#)
- 4.2. [Settings](#)
- 4.3. [Workflow Overview](#)
- 4.4. [Quick Press](#)
- 4.5. [Last Run Data](#)
- 4.6. [Edit Recipe](#)
  - 4.6.1. [Edit Recipe Cont.](#)
- 4.7. [Preset Recipes](#)
- 4.8. [Recipes \(List\)](#)
- 4.9. [Run Recipe](#)
- 4.10. [Pre-heat](#)
- 4.11. [Software Updates](#)

## 5. [Press Operation](#)

- 5.1. [Loading the Press](#)
- 5.2. [Automated Pressure Control](#)
- 5.3. [Dual Pressure Control](#)
- 5.4. [Plate Speed Control](#)
- 5.5. [Pressing Material](#)

## 6. [Maintenance & Troubleshooting](#)

- 6.1. [Common Issues](#)
- 6.2. [FAQ Part 1](#)
- 6.3. [FAQ Part 2](#)
- 6.4. [Truss Service Instructions](#)

# 1. Introduction

2



**From all of us here at PurePressure, thank you for your purchase!**

Our rosin presses are engineered to last for many years with proper care. The following user manual covers virtually every topic, including how to use the press, technical specifications, tips on getting the most out of your equipment, and much more.

Unless otherwise noted, the instructions contained in this manual apply to both the Pikes Peak V2 and Longs Peak rosin presses and are interchangeable.

**Sales Inquiries:**

[sales@gopurepressure.com](mailto:sales@gopurepressure.com)

**General Questions:**

[info@gopurepressure.com](mailto:info@gopurepressure.com)

**Technical Support:**

[support@gopurepressure.com](mailto:support@gopurepressure.com)

**Contact:**

 720-446-9565

 [purepressure.com](http://purepressure.com)

   @gopurepressure

— **We're always here to help. Talk to us!**

# 1.1 Warranty

3

**PurePressure's rosin presses are built to last for many years with proper care.** We want you to be satisfied with your equipment so if there are ever any concerns, please do not hesitate to contact us. PurePressure guarantees the following warranty coverage for both the Pikes Peak and Longs Peak rosin presses:

- 2 year limited warranty against manufacturing defects for structural components (frame, truss and support legs) and pneumatic cylinder.
- 1 year limited warranty against manufacturing defects for the entire press including electronic and pneumatic components.

**Warranty Replacements:** In event of an approved warranty replacement or service, PurePressure will supply the necessary part(s) and special tools, if needed. Shipping costs may be covered by PurePressure at its discretion.

**Replacement Parts:** Replacement parts for various components are available at reasonable prices for press owners directly from PurePressure.

**Exclusions: Warranty coverage eligibility will be determined by PurePressure and at PurePressure's sole discretion.** PurePressure's warranty obligations do not include (i) reasonable wear and tear; (ii) damage or corrosion caused by outdoor elements or outdoor use; (iii) use of unapproved parts or unproved alterations to components; (iv) defects or damage caused by misuse, improper electrical power supply, or compressed air inputs over 150 PSI (v) pneumatic components damaged from internal moisture or having been pressurized with compressed air which is not clean or dry; (vi) vandalism, negligence, misuse or Force Majeure Events; or (vi) items expected to be consumed or expended during the normal and routine operation and maintenance. This warranty is eligible for the original purchaser only and is not transferable.

**Disclaimer:** Except as expressly set forth in this Limited Warranty and to the greatest extent allowed by law, PurePressure makes no other representations, warranties or conditions, express or implied, including any implied representations, warranties or conditions of merchantability, fitness for a particular purpose, non-infringement, and non-interference.

**Warranty Procedures:** If your press is covered under the warranty period, please contact us with detailed information regarding the issue you are experiencing so that we can get you operational as soon as possible. If you are experiencing a problem and are outside of the warranty period, we will do everything in our power to get you affordable replacement component(s) in a timely manner. Please send all warranty and replacement part related inquiries to [support@gopurepressure.com](mailto:support@gopurepressure.com). All returned parts must be accompanied by an RMA number, which we will supply.



# 1.2 What's Included

## What's Included With Your Press

*(items may differ depending on kit or model)*

- LED capacitive touch screen
- Two button safety start
- Emergency-stop
- Plate speed actuation dial
- Compressed air filter / regulator(s)
- Pressure toggle for ramping control or internal automated pressure control unit
- Parchment clips
- Vertical orientation legs (qty 2)
- Horizontal orientation legs (qty 2)
- Leveling feet (qty 4)
- Industrial 1/4" male air fitting
- Power cable

### Pikes Peak V2



5 Tons of Force

### Longs Peak



8 Tons of Force

# 1.3 Technical Specifications

Specification	Pikes Peak V2	Longs Peak
Weight	120 lb	130 lb
Overall Dimensions Depth x Width x Height	<b>Horizontal:</b> 29.2" x 19.7" x 13.5" <b>Vertical:</b> 15.5" x 19.7" x 33.3"	<b>Horizontal:</b> 32.6" x 19.7" x 13.5" <b>Vertical:</b> 15.5" x 19.7" x 36.8"
Power Requirement	120/240VAC 8A at startup / 2A continuous	120/240VAC 8A at startup / 2A continuous
Fuses (2x)	<b>Type:</b> Fast Acting 250V <b>Current:</b> 10A <b>Dimensions:</b> 5mm x 20mm	<b>Type:</b> Fast Acting 250V <b>Current:</b> 10A <b>Dimensions:</b> 5mm x 20mm
Compressed Air Requirements	<b>PSI:</b> 5 - 120 <b>CFM:</b> 2.1 or greater Dry clean air	<b>PSI:</b> 5 - 140 <b>CFM:</b> 2.7 or greater Dry clean air
Pneumatic Cylinder Maximum Force Output	9,876 lb @ 120 PSI	15,300 lb @ 140 PSI
Frame & Enclosure Metal	A36 Steel	A36 Steel
Heat Plates	<b>Sizes:</b> 10" x 2.5" <b>Material:</b> 6061 Aluminum <b>Maximum Temperature:</b> 300 °F	<b>Sizes:</b> 10" x 3" <b>Material:</b> 6061 Aluminum <b>Maximum Temperature:</b> 300 °F

## 1.4 Disclaimers & Safety Precautions

6



Please review this information carefully prior to press operation!

**WARNING:** HEAT PLATES CAN CAUSE SERIOUS BURNS. NEVER PLACE FOREIGN OBJECTS, FINGERS, HANDS OR OTHER BODY PARTS ON OR BETWEEN THE HEAT PLATES.

**WARNING:** PINCH POINT CAN CAUSE SERIOUS INJURY. NEVER PLACE FOREIGN OBJECTS, FINGERS, HANDS OR OTHER BODY PARTS ON OR BETWEEN THE HEAT PLATES.

**WARNING:** ALWAYS WEAR EYE AND EAR PROTECTION AS WELL AS HEAT RESISTANT GLOVES FOR SAFE OPERATION.

**WARNING:** PUREPRESSURE, LLC IS NOT RESPONSIBLE FOR INJURY OR LOSS DUE TO IMPROPER USE OF EQUIPMENT.

**DISCLAIMER:** COMPRESSED AIR SOURCE REQUIRED. MAX ALLOWABLE WORKING PRESSURE 140PSI. THIS PRODUCT OPERATES UTILIZING A PNEUMATIC CYLINDER.

**DISCLAIMER:** YOUR PRESS SPEED VALVE IS TURNED OFF FOR SHIPPING. THE DIAL MUST BE OPENED TO OPERATE YOUR PRESS PNEUMATIC.

**DISCLAIMER:** CONNECTING TO ANY OTHER POWER SOURCE OTHER THAN WHAT YOUR PRESS IS RATED FOR ON ITS SERIAL LABEL WILL VOID YOUR WARRANTY.

**WARNING:** EXCEEDING 150PSI ON YOUR PRESS WILL TERMINATE YOUR WARRANTY. A MECHANICAL BLOW OFF VALVE WILL EXHAUST AND YOUR FIRMWARE WILL DETECT THE OVERPRESSURE FAULT.

**WARNING:** ONLY USE THE DESIGNATED AC POWER PLUG PROVIDED WITH YOUR PRESS. USING ALTERNATE VOLTAGES OTHER THAN SPECIFIED CAN RESULT IN DAMAGE TO YOUR UNIT.

**WARNING:** IF THE HEAT PLATE ICON ON YOUR SCREEN IS RED THEN THE PLATES ARE HOT ENOUGH TO CAUSE BURNS.

**WARNING:** PARCHMENT CLIPS ARE NOT HANDLES. DO NOT USE TO LIFT THE PRESS.

**WARNING:** EMERGENCY STOP BUTTON - YOU MAY CANCEL THE OPERATION AT ANY POINT BY PRESSING THE EMERGENCY STOP BUTTON. THIS WILL DISPLAY EMERGENCY STOP ON THE LED TOUCH SCREEN AND WILL CUT POWER TO THE HEATERS WHILE RETRACTING THE AIR CYLINDER. **NOTE:** AN INLET AIR SUPPLY OF AT LEAST 10 PSI IS REQUIRED FOR THE CYLINDER TO RETRACT. DISCONNECTING THE AIR SUPPLY PRIOR TO PRESSING THE EMERGENCY STOP BUTTON WILL NOT RETRACT THE PRESS. TO CLEAR THE EMERGENCY STOP, TWIST THE BUTTON TO RELEASE. THIS WILL REBOOT THE SYSTEM AND RETURN YOU TO THE MAIN MENU. THE HEATERS WILL BE OFF AT THIS POINT.

**WARNING:** DO NOT PRESS ANYTHING OTHER THAN SOFT PLANT MATERIALS IN THE PIKES PEAK, PIKES PEAK V2, OR LONGS PEAK PRESS. PRESSING OTHER OBJECTS WILL VOID THE WARRANTY.

**WARNING:** WHEN USING ISOPROPYL ALCOHOL TO CLEAN THE HEAT PLATES THE POWER SHOULD BE DISCONNECTED, AND THE HEAT PLATES SHOULD BE AT ROOM TEMPERATURE. ALWAYS WEAR GLOVES AND EYE PROTECTION.

# 1.5 Uncrating Your Press

## Steps to Safely Uncrate Your Press

**Note:** Use two people to lift the press safely.

1. Using a Phillips screwdriver or power tool, remove wood screws from top lid. **(Figure 1A)**
2. Lift off crate cover.
3. Remove contents from top section and remove crate shelf. **(Figure 2A)**
4. Remove the loose foam packing blocks around the press (some foam blocks are glued to the crate itself - do not remove them).
5. Using the two straps around the press pull straight up to remove the press from the crate and set on a sturdy table. **(Figure 3A)**
6. Remove the plastic wrapping and set your Dual Pressure kit as well as your vertical legs aside.
7. Turn your emergency stop button clockwise to release.
8. Turn your Speed Controller knob all the way counter clockwise to open the valve. This will allow the plates to fully actuate.

Figure 1A



Figure 2A



Figure 4A





## 2. Press Setup

8

**Note:** Your press comes set up in the horizontal orientation for shipping purposes.

### Vertical vs. Horizontal Orientation

Most users will encounter greater utility and productivity using the Pikes Peak V2 or Longs Peak rosin press in the vertical orientation. This is because loading and unloading bags and parchment tends to be easier. It is our recommendation that you become familiar with the press in the vertical orientation first, and then move to the horizontal orientation if desired.

For horizontal orientation pressing, virtually any of our silicone products or parchment paper works well as a collection surface.



## 2.1 Vertical Orientation Setup

9

### Vertical Orientation Setup

**Warning:** HEAVY EQUIPMENT! Two people recommended for setting up the press vertically or horizontally.

1. The vertical orientation requires the two triangular shaped legs. To change to the vertical orientation from the default horizontal orientation, carefully bring the two front legs off the edge of a table while ensuring the press will not fall forward. **(Figure 1A)**
2. Using a ¼" Allen wrench or bit, remove the (qty4) screws securing the horizontal legs as well as the (qty2) adjacent screws just above them. Remove legs on both sides. **(Figure 2A)**
3. Line up each vertical triangular leg to the three blank holes on the side of the frame and then replace the (qty 3) screws on each side. **(Figure 3A)**
4. Then, fasten leveling feet into place, and lift the press into the full upright vertical orientation.
5. Place the touchscreen display enclosure to the recessed position so it is flush with the front of the press.

*Vertically Oriented Pikes Peak*



**Figure 2A**



**Note:** Leave leg bolts barely loose so the press can be leveled before tightening in place.

**Figure 1A**



**Figure 3A**



## 2.2 Horizontal Orientation Setup

10

### Horizontal Orientation Setup

**Warning:** HEAVY EQUIPMENT. Two people recommended for setting up the press vertically or horizontally.

1. The horizontal orientation requires the two short rectangular legs. To change to the horizontal orientation from the vertical orientation, first lean the press slightly forward and have a friend unscrew the leveling feet. Then, re-screw two of the leveling feet into the two holes on back of the press, near the top.
2. Next, carefully lay the press on its back and using a ¼" Allen wrench or bit, remove the (qty6) screws securing the vertical legs. **(Figure 1A)**
3. Line up each horizontal rectangular leg to the two blank holes on the side of the frame and then replace the (qty 2) screws on each side. **(Figure 2A)**. Put the additional remaining screw in the empty holes on each side.
4. Then, fasten leveling feet (qty2) on the bottom screw hole ports of the horizontal rectangular legs. **(Figure 3A)**
5. Slide your press back so it sits securely on your table for operation.

*Horizontally Oriented Pikes Peak*



*Figure 1A*



*Figure 2A*



*Figure 3A*





## 2.3 Vertical Dual Pressure Installation

11

**Note:** Your Dual Pressure system installs easily in both the horizontal and vertical orientations with just a Phillips screwdriver. There is a separate bag included in your press kit with additional pneumatic tubing for the horizontal setup..

### Hooking Up Your Dual Pressure Regulators

#### Vertical orientation installation detailed below

1. Unscrew the black collar nuts (qty2) atop each regulator and remove the aluminum mounting bracket. Using the short screws (qty2), attach the bracket to your press. **(Figure 1A)**. Tighten them with your Phillips screwdriver. For horizontal setup, simply install the bracket perpendicular to this so that the regulators are always vertically oriented. This allows the condensate trap to function properly.
2. Take your Dual Pressure regulators and re-insert both through the mounting bracket. Then, re-screw on your black regulator collar nuts onto both sides so they are hand tight. **(Figure 2A)**
3. Next, using the long screws (qty3) provided, attach your Dual Pressure toggle switch and tighten each screw. **(Figure 3A)**
4. Attach your short pneumatic hose from the toggle switch to the push connect fitting on the press, and then attach the pneumatic hoses from the Dual Pressure regulators to the toggle switch. **(Figure 4A)**
5. In the vertical orientation, your pneumatic tubing from the Dual Pressure regulators should cross and all push fittings should be firmly seated.

Figure 1A



Figure 3A

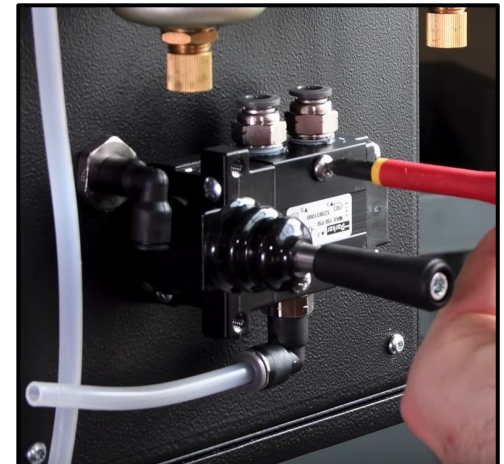
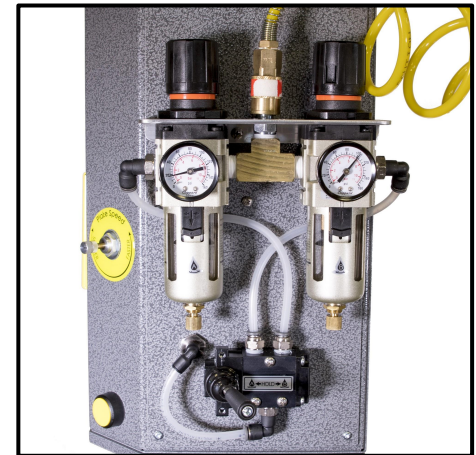

Figure 2A



Figure 4A





## 2.4 Horizontal Dual Pressure Installation

12

**Note:** Your Dual Pressure system installs easily in both the horizontal and vertical orientations with just a Phillips screwdriver. There is a separate bag included in your press kit with additional pneumatic tubing for the horizontal setup.

### Hooking Up Your Dual Pressure Regulators

#### Horizontal orientation installation detailed below

1. Unscrew the black collar nuts (qty2) atop each regulator and remove the aluminum mounting bracket. Using the short screws (qty2), attach the bracket to your press. **(Figure 1A)**. Tighten them with your Phillips screwdriver. For horizontal setup, simply install the bracket perpendicular to this so that the regulators are always vertically oriented. This allows the condensate trap to function properly.
2. Take your Dual Pressure regulators and re-insert both through the mounting bracket. Then, re-screw on your black regulator collar nuts onto both sides so they are hand tight. **(Figure 2A)**
3. Next, using the long screws (qty3) provided, attach your Dual Pressure toggle switch and tighten each screw. **(Figure 3A)**
4. Attach your short pneumatic hose from the toggle switch to the push connect fitting on the press, and then attach the pneumatic hoses from the Dual Pressure regulators to the toggle switch.
5. In the horizontal orientation, your pneumatic tubing from the Dual Pressure regulators should not cross and all push fittings should be firmly seated. **(Figure 4A)**

Figure 1A

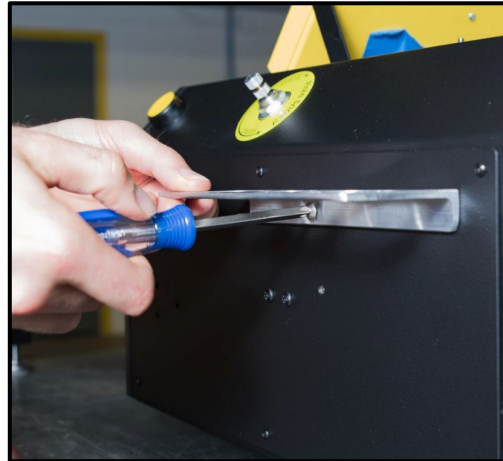

Figure 3A

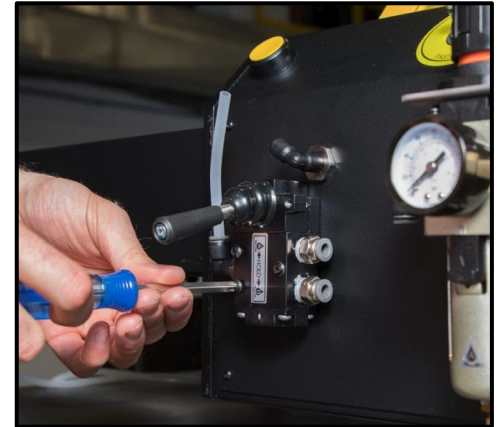

Figure 2A

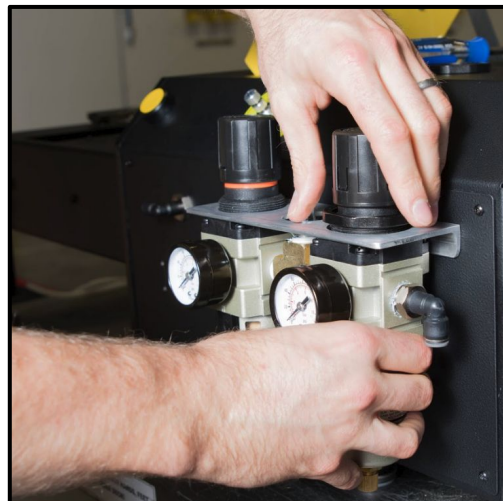
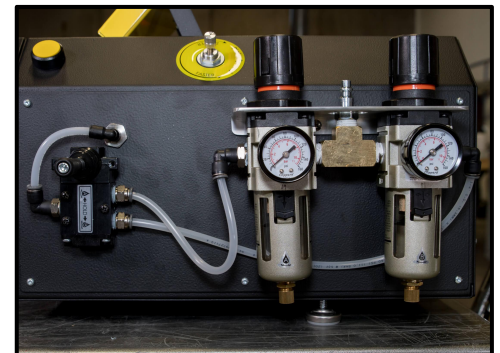

Figure 4A



## 2.5 Automated Pressure Control Installation

13

**Note:** Your Automated Pressure Control system also installs easily in both the horizontal and vertical orientations with just a Phillips screwdriver.

### Hooking Up Your Automated Pressure Control Regulator

#### Vertical orientation installation detailed below

1. Unscrew the black collar nut (qty1) atop the regulator and remove the single hoop aluminum mounting bracket. Using the short screws (qty2), attach the bracket to your press. **(Figure 1A)**. Tighten them with your Phillips screwdriver. For horizontal setup, simply install the bracket perpendicular to this so that the regulator is vertically oriented.
2. Take your single regulator and re-insert it through the mounting bracket. Then, re-screw on your black regulator collar nut onto both sides so they are hand tight. **(Figure 2A)**
3. Next, attach your short pneumatic hose from the left side of the air regulator to the push connect fitting on the press by carefully pushing it into the black hose port. **(Figure 3A)**
4. Finally, ensure that your push connect fitting is snug by gently pulling on it to ensure it's seated fully.

**For horizontal installation, repeat these same steps and make sure to mount your regulator bracket and regulator so that its cap is upward.**

All other components of your Automated Pressure Control unit are internally mounted and ready to operate once your air regulator has been properly installed as shown here.

*Figure 1A*



*Figure 3A*



*Figure 2A*



## 2.6 Using Push Connect Fittings

14

### Attaching & Using Push Connect Fittings

Your push connect fittings securely hold your pneumatic tubing in place.

#### To Insert:

1. Simply take your pneumatic tubing and insert it as far into the fitting as it will sit. **(Figure 1A)**
2. Verify it is fully connected and seated by gently pulling back on the hose. It should not give and will remain secured.

#### To Remove:

1. Using your fingers, push down on the grey ring as much as you are able (it will only move downward a tiny bit).
2. While pushing down on the grey ring, gently push the pneumatic hose into the fitting, and then pull outward to remove. If it is not releasing, push down slightly harder onto the grey ring to release the tubing.

Figure 1A





## 2.7 Electrical Power

15

**Note:** Your product serial label will indicate if your press is rated for 120/240VAC or just 120VAC. The fuses on this machine should now under normal operation. Should your fuses blow, it is likely that there is a problem with the supplied power.

### Power Module

Your press kit will come with an appropriate power cable for your location.

**Power Draw:** 8 amps while heat ramping, 2 amps continuous draw.

**Emergency Stop:** In the event of an emergency, pushing the E-Stop button disconnects power to the heaters and the solenoid valve. Disconnecting power to the solenoid valve will cause the plates to immediately retract so long as an air supply (10 PSI minimum for the Pikes Peak and 20 PSI minimum for the Longs Peak ) is supplied.

### Fuse Replacement

1. Ensure the power switch is in the OFF position and remove the power cable. Wait for at least 60 seconds.
2. Using a small screwdriver, gently pry loose and remove the fuse holder. **(Figures 1A, 2A)**
3. Carefully replace the fuses [Fast Acting 250V, 10A, 5mm x 20mm]. **(Figure 3A)**

Figure 1A



Figure 2A



Figure 3A



## 2.8 Compressed Air

16

**Note:** The Pikes Peak V2 (5 PSI minimum) and Longs Peak (5 PSI minimum) both require compressed air supply to actuate the plates down as well as to retract them.

### Pneumatic Operation

Both the Pikes Peak V2 and Longs Peak require clean, dry compressed air for long term reliability. While there are many brands and types of air compressors, we specifically suggest a California Air Tools CAT15020C, Quincy QT54 package, or a Chicago Pneumatic QRS air compressor depending on your total compressed air needs, which can all be found on our website at [www.purepressure.com](http://www.purepressure.com).

Please contact us if you are unsure which air compressor to get and we would gladly help you select the right unit! Make sure to check out our [Universal Air Compressor Connection](#) kit if you aren't sure which tubing and fittings you may need.

#### Pikes Peak V2 Recommended Air Compressor Specifications

**Maximum PSI:** 140 +

**CFM Output:** 2.1 +

**Storage Tank Size:** 30 gallons +

#### Longs Peak Recommended Air Compressor Specifications

**Maximum PSI:** 150 +

**CFM Output:** 2.7 +

**Storage Tank Size:** 30 gallons +

If you do not already have the necessary fittings and tubing, check out our Pneumatics Kit on our website. To hook up your air compressor, attach your pneumatic hose from your air compressor to your Pikes Peak V2 or Longs Peak rosin press with a 1/4" industrial quick connect fitting. **(Figure 1A)**

Figure 1A

1/4" Industrial Quick Connect Fitting

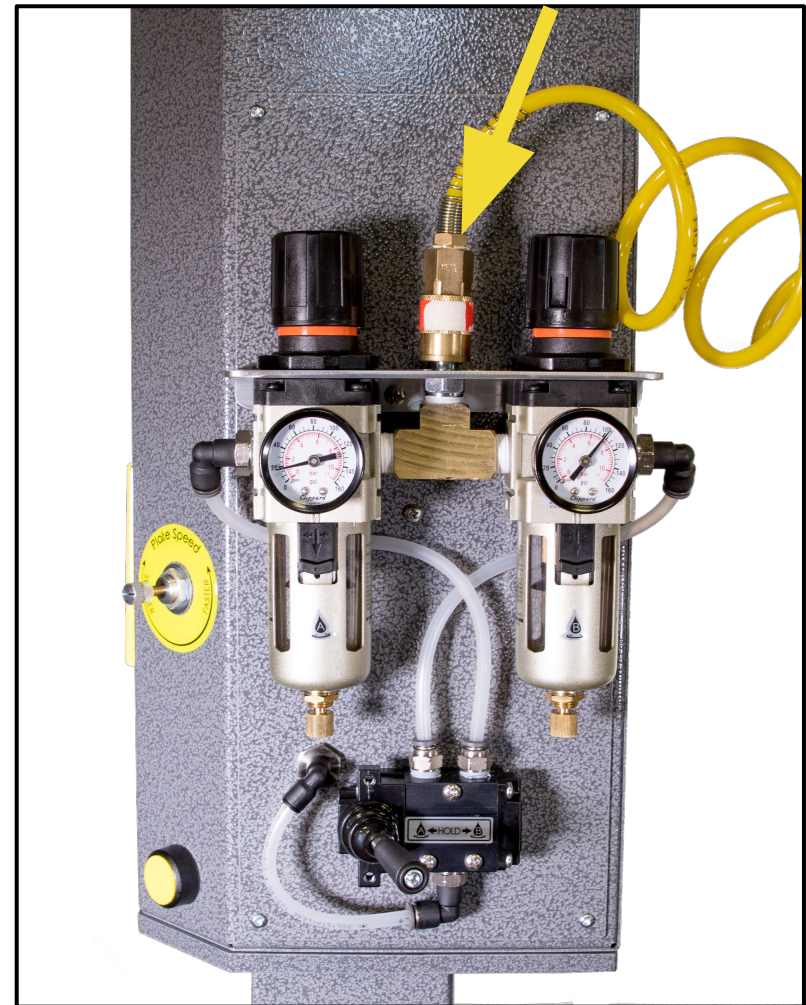

# 3. Rosin Extraction Basics

## Rosin is created with heat, pressure, and filtration.

- The heat being applied to your material liquefies the glandular trichome heads present in cannabis, then the pressure forces the resulting cannabinoid-rich oil through the filtration media.
- Technically speaking, rosin is a mechanical separation process, as opposed to a true “extraction”. However, the term extraction is used interchangeably with solvent-based and solvent-less processes.
- Rosin can be produced with a variety of different textures or consistencies and has a potency level that is on par with hydrocarbon-based extraction (60% - 90% +). Rosin can also often be extremely terpene-rich and aromatic if high quality material is being pressed.
- Different materials, strains, growing media, and other factors contribute to the yield and quality of your rosin. We encourage ample experimentation with your material to dial in the perfect settings with your PurePressure rosin press to get the best results possible!

## Consistencies & Textures



Lower temperatures tend to produce budders and batters, where higher temperatures can often produce a shatter or oil-like consistency. Depending on your material, rosin can be made into sugar, wax, shatter sauce, budder, and more!

## Live Rosin



Live rosin is made by washing fresh frozen cannabis into bubble hash and then pressing it into rosin. For optimal results, use a freeze dryer to dry your hash in order to get the best color and terpene profile.

## 3.1 Tips & Tricks

18

### Top Rosin Tips

1. For the best, lightest color possible, use extremely fresh dried material.
2. Always make sure your flower is properly cured. Flowers should be between 55% - 62% RH in the jar for optimal yields with flower rosin.
3. Quality in = quality out. Use the best material available for stellar results.
4. Typically higher temperatures will increase yield and decrease terpene preservation. Lower temperatures will ensure the highest level of terpene preservation but tend to decrease yields. Press accordingly!
5. For optimal terpene preservation, do not press rosin above 220 °F unless you know what you are doing.
6. Making rosin is easy. Stick with it and keep experimenting with your variables until you get it just right for your material.

### Tricks to Help You Press Amazing Rosin

1. Making great rosin always starts in the garden. Certain strains will over perform, and others will underperform, so always go into the process with quality in mind.
2. Press within a few weeks after harvesting, if possible. Older material tends to underperform both with yield and clarity. As your material ages, it oxidizes and chemical changes occur within the cannabinoids themselves, making it both less potent and less terpene-rich.
3. Store your rosin in an airtight container within a cooled environment (such as a refrigerator or freezer) to preserve terpenes and texture.
4. Experiment with different starting materials. If you normally press flower, try your hand at making bubble hash or tumbling some kief. The possibilities with rosin are endless - fresh frozen live rosin, rosin sauce, solvent-less THCA separation, and more can be made with a PurePressure rosin press.



## 3.2 Choosing Your Material

19

### Starting Material and Filter Type

1. First and foremost, you will need to choose what kind of starting material you intend to press into rosin. The most common materials used in this process are freshly dried cannabis flowers, kief (or dry sift), or ice water bubble hash. We do not recommend pressing trim as-is because of the amount of inert plant material your oil must travel through to escape the bag. You will achieve greater yields and a better product sifting your trim first.
2. Next, you'll need to select the micron filter size you wish to use. A larger micron number corresponds to larger pore openings in the mesh fabric. We typically recommend 25 $\mu$ m or 36 $\mu$ m for dry sift and hash, and 115 $\mu$ m for flower and shake.

**Bubble Hash**



**Dry Sift / Kief**

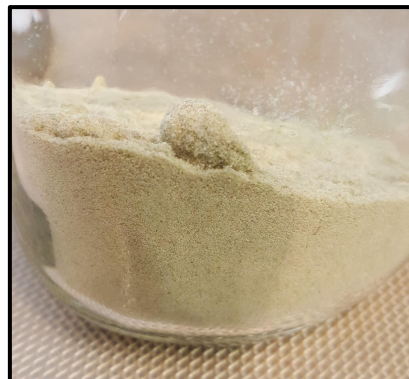

**Flower**



**Micron Usages**

25 $\mu$ m/36 $\mu$ m/72 $\mu$ m

Ideal for bubble hash, dry sift

90 $\mu$ m/115 $\mu$ m

Ideal for flower, shake



### 3.3 Yield & Material Types

**Note:** Some strains tend to yield very well, whereas others may not. Try not to get discouraged if your yields aren't what you expected on your first press. Heavily resinous, terpene-rich strains will always yield the highest quality rosin!



### Max Yield % vs Bag Pressure

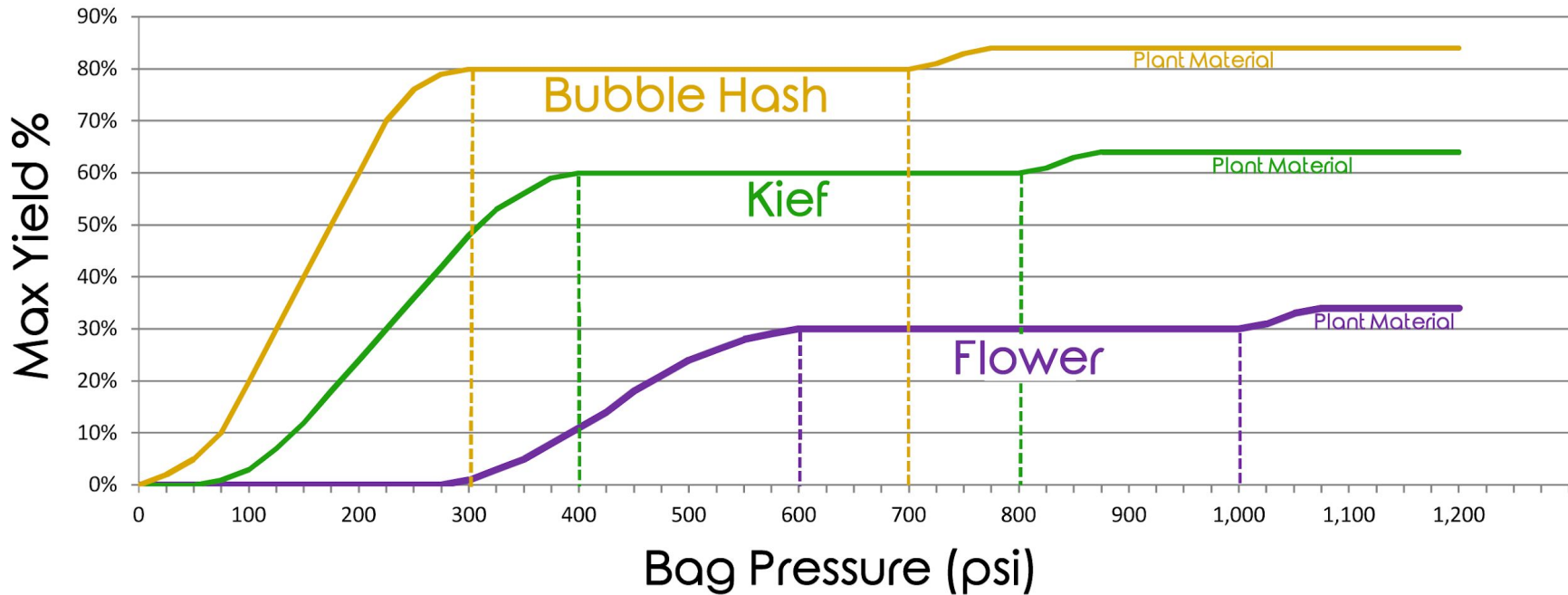

**PSI:** The PSI on the X axis refers to the pressure at your bag, not the compressed air pressure that is available from your air compressor.

While the Pikes Peak V2 and Longs Peak can automatically calculate bag pressure, the formula is as follows:  
(Pressing Force / Bag Area (sq inches)) = PSI at the Bag

**Example:**  
(9,000 LBF) / (12 square inch bag) = 750 PSI at the bag

## 3.4 Filter Bag Preparation

Visit our YouTube channel for helpful how-to videos!

You @GoPurePressure  
Tube [YouTube.com/c/GoPurePressure](https://www.youtube.com/c/GoPurePressure)

21

### Properly Filling Your Rosin Filter Bag

1. Turn your PurePressure rosin filter bag inside out using the Quick Flip tool. **(Figures 1-3A)**
2. Using the provided filling funnel, fill the bag with your material, making sure it is evenly distributed in the bag and that there is at least  $\frac{3}{4}$ " left at the end of your bag to fold over. **(Figures 1-2B)**
3. Fold over the remaining, unfilled portion of your rosin filter bag and insert the bag, folded-side down, into chamber of your pre-press mold. Replace the top of the pre-press mold and push down with hand pressure, or use an arbor press (1 ton max). **(Figure 1C)**
4. Flip your pre-press mold over, remove the top facing plate, and press down on the middle chamber to release your prepared rosin filter bag.

Figure 1A



Figure 2A



Figure 3A



Figure 1B

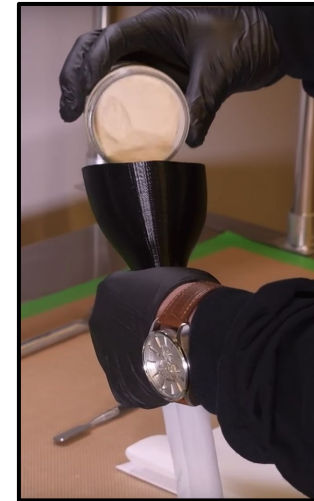

Figure 2B

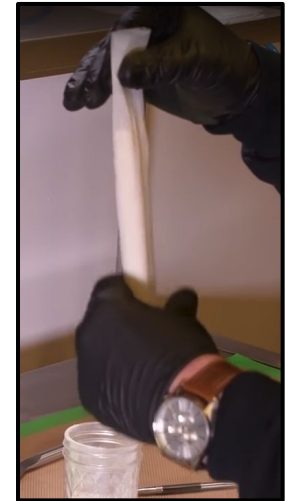

Figure 1C



See [page 32](#) in this manual for maximum recommended filling capacities and other helpful tips for your process.

## 4. Pressware Controls

22

PurePressure's Pressware has been designed and engineered specifically for solventless cannabinoid oil extraction.

### The Pressware Interface Allows for Total Control

Heat, press time, pressure stages for repeatable results, and more are all custom controlled by the most consistent results in the market. With individually customizable pressure stages and ultra accurate temperature control, you can ensure that your results are always consistent.

In the settings menu, you can also modify the interface units individually to be metric or imperial.

Depending on which pressure control unit you've purchased, there will be different options available for the manual Dual Pressure versus the Automated Pressure presses. You can upgrade your press to the Automated version at any time by [www.purepressure.com](http://www.purepressure.com) and purchasing the upgrade kit.

In the following sections we will cover exactly how to use your Pressware controls and how you can get the most out of your PurePressure rosin press.



Save Up to 29 Recipes



Touchscreen LCD Tech





# 4.1 Home Screen

The Home Screen appears after startup from this screen you can manage heater settings, view active pressure values, view a loaded recipe and navigate to a variety of menu options. You cannot press while on the Home Screen.

### 1: Heaters 1 and 2

Tap to turn your upper and lower heaters on and off.

### 2: Quick Press

Start pressing immediately with your current settings. You can also save your Quick Press settings in order to build a new recipe from the Last Run Data tab.

### 3: Run Recipe

Load and use an existing pre-made or custom recipe.

### 4: Last Run Data

View the data from your last pressing operation. This includes heat, time, pressure, and pressure stages.

### 5: Temperature Settings

Tap to set and change your temperature on your top and bottom plates; red indicates the plate surfaces are hot enough to burn you.

### 6: Loaded Recipe

If you're running a recipe, it will display which one you are using here.

### 7: Home Button

Return to the home screen at any time.

### 8: Force Toggle Button

1) Tap to view your total available force, compressed air PSI, and pressure at the bag (if set).  
2) You may also adjust your pressure digitally with the Automated Pressure system here as well.

### 9: System Settings

Review and adjust your values for Imperial or Metric as well as your desired buzzer sound level and adjust operating voltages.

### 10: Recipes

View, save, edit, and load all of your pre-saved recipes - you may have up to 30 saved at one time.

### 11: Contact Info

Return to the home screen at any time.

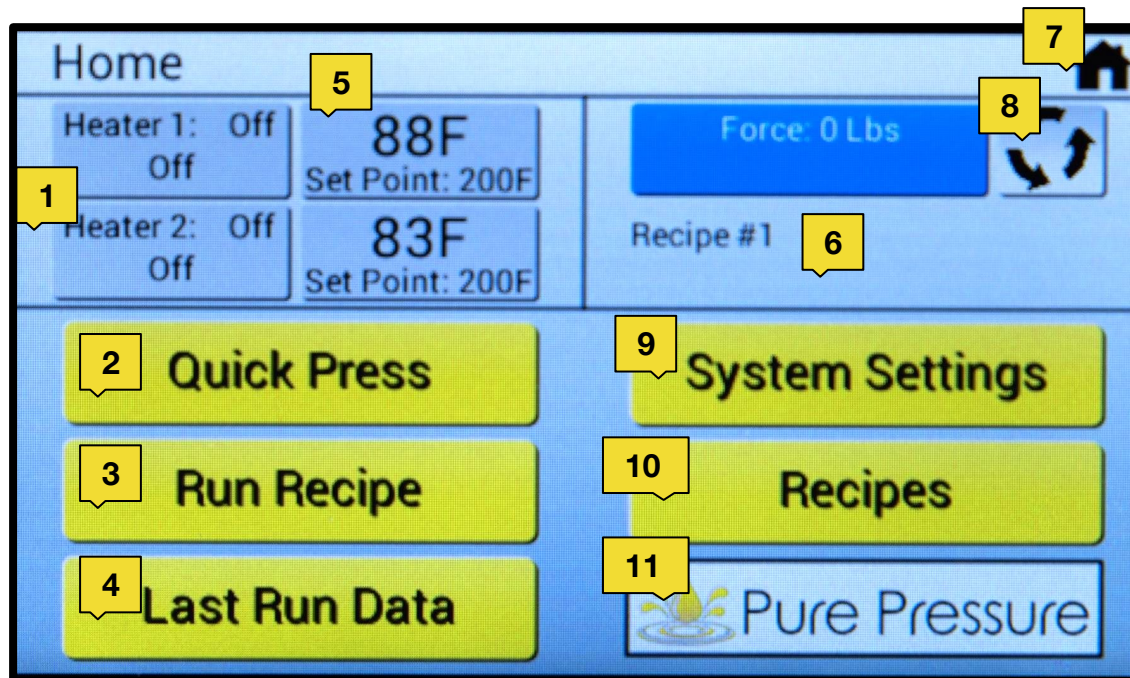

## 4.2 System Settings

24

**Note:** Adjusting the temperature or pressure units will require you to convert these values manually in any saved recipes.

You can adjust your System Settings at any time. This will allow you to change a few key things, including whether your press displays numbers in Imperial or Metric, as well as how loud you want the beeping indicator to be (you can also silence it) to alert you during cycle pressure changes.

### 1: Force

Displays in either LB or KG.

### 2: Temperature

Displays in either Fahrenheit or Celsius.

### 3: Compressor

Max air pressure setting. Not available on Dual Pressure systems.

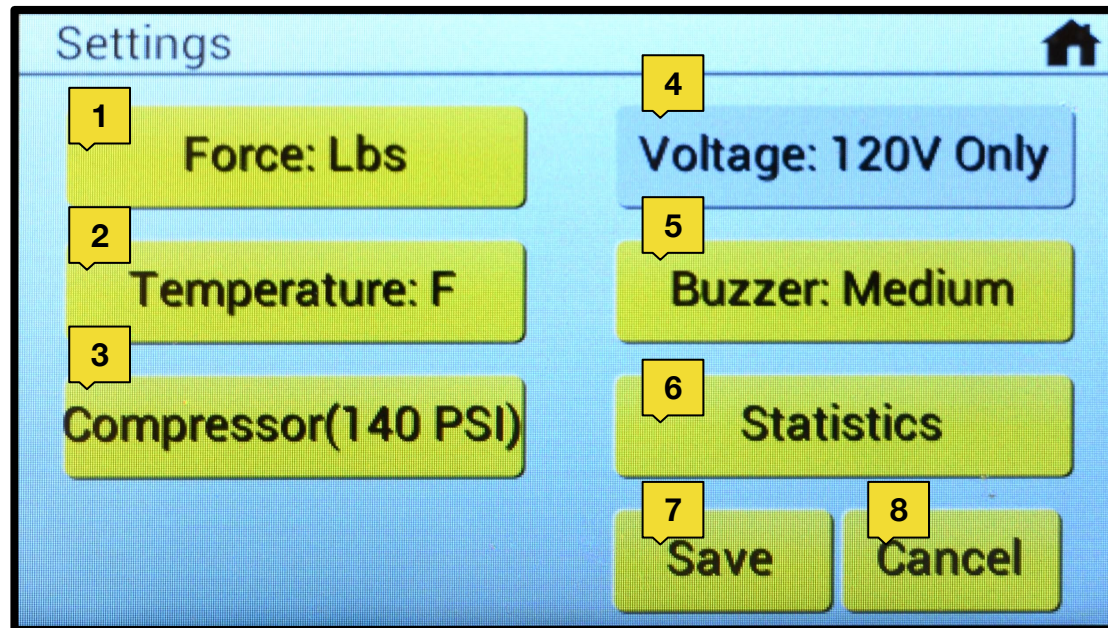

### 4: Input Volts

Displays 120 or 240 depending on your system's capabilities. If this option is not available, your press is only capable of operating on 120 VAC.

### 5: Buzzer

Noise settings available are high, medium, low, and silent or off.

### 6: Statistics

This tab offers detailed information about your press, usage stats, and error codes for debugging if necessary.

### 7: Save

Saves your settings.

### 8: Cancel

Exits the menu without saving any changes.

## 4.3 Workflow Overview

25

### One-off Press

---

Quick Press

### Creating a Recipe

---

Quick Press

Last Run  
Data

Edit Recipe

Run Recipe

### Pressing a Known Material

---

Recipe / Run  
Recipe  
Select

Run Recipe

Repeat  
Recipe

Repeat  
Recipe



## 4.4 Quick Press

26

**Note:** When using the Automated Pressure system, whenever you use the force increase or decrease buttons, the Air Pressure toggle will turn yellow and wait two seconds to accept the value before executing the command.

**Quick Press is one of Pressware's most powerful features because it allows you to save your parameters into a recipe for later use!** Set your temperature and starting pressure, and then begin pressing using two yellow start buttons. Hold for 5 seconds to fully initiate the press.

- Using the Quick Press menu is the easiest way to start pressing and figure out how to run a good recipe for your material. It will enable you to store up to 6 pressure stages and the time you spent on each.
- When using the Automated Pressure system, your pressure stages will be logged automatically as you change pressure.
- When using the Dual Pressure system, simply hit "Next Stage" to record your maximum force and initiate the next stage.
- Once you get the perfect press from your material, you can then view your Last Run Data and save all of your settings into a stored recipe!

**Note:** Your notification bar will display your current stage, any notifications, errors, and so on.

Stage#	1	2	3	4	5	6	Max
Time	00:11	00:04	00:09	00:01	00:00	00:00	00:25
Pressure	14	25	50	55	0	0	50

**Note:** For each pressure stage, the total time spent and maximum pressure achieved is what will be recorded. On the Dual Pressure system, you will need to manually hit "Next Stage" to record the next stage.

## 4.5 Last Run Data

27

Once you've pressed, the Last Run Data menu will tell you exactly what you did and how you did it. You can save this information directly into a new recipe, or just look to see what you want to change for your next press.

1. The press records your set temperature, total press time, pressure, and pressure stages from your most recent press cycle.
2. The Last Run Data menu is the most accurate way to dial in your settings by learning what you did and then adjusting from there.
3. Easily save your Last Run Data settings directly into a new Recipe, where you can make changes or re-use those settings at will.

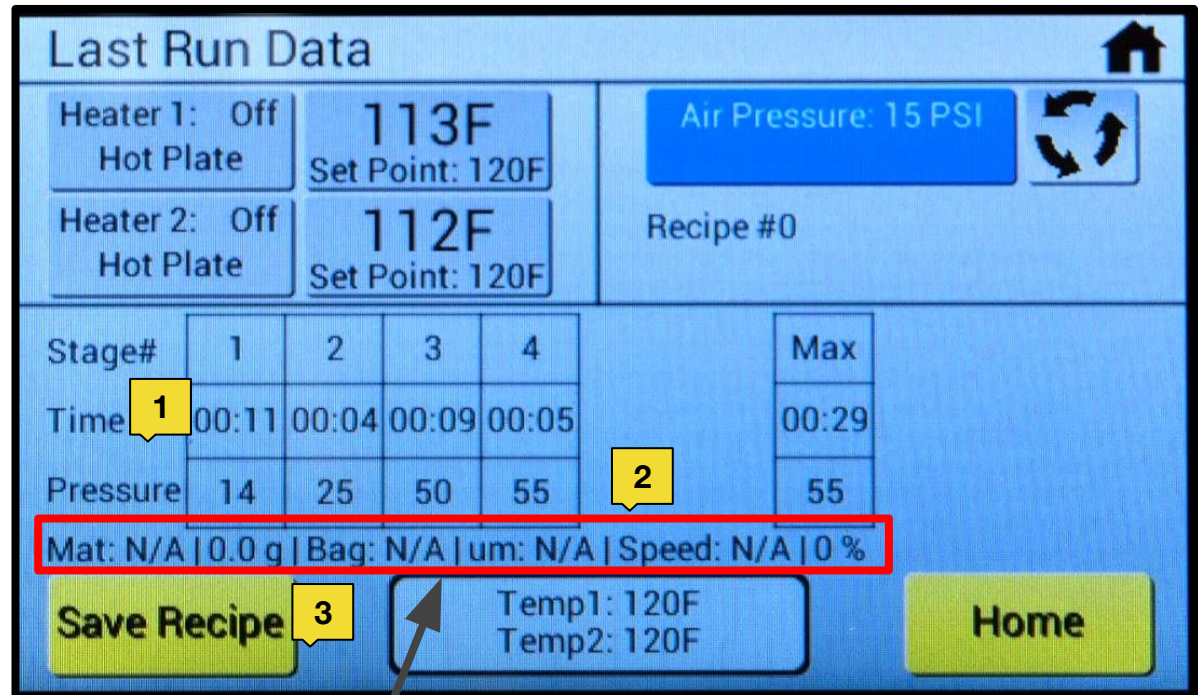

**Note:** These inputs are dependent on the user and are not automatically captured by the press when saved into a recipe if you are running a Quick Press, or will display if you are viewing Last Run Data from running a pre-existing recipe.



## 4.6 Edit Recipe

28

**With Recipes, you can save every variable and then your press will run those settings at the push of a button.**

- You can store up to 29 recipes to be repeated and used later.
- These menu options enable you to run our pre-loaded recipes, which cover most materials and bag sizes for instant results.
- Recipes can be created either manually with these menu options, or from a Last Run Data set.
- Selecting a bag size will allow the press to automatically calculate the exact pressure at your bag.
- Recipes will automatically control your temperature and press time. The Automated System also saves and executes pre-set pressure ramping.
- Material, weight, bag micron type, actuation speed, and humidity are all for reference purposes.

The screenshot shows a 'Edit Recipe' screen with the following parameters and controls:

Parameter	Value
Material	Kief
Weight (g)	20.0
Bag Size	2"x9"
Micron	72 um
Speed	Slow
Humidity	50 %
Stage#	1, 2, 3
Time	00:34, 00:26, 00:18
Pressure	50, 70, 72
Heater1	200
Heater2	200

Max Pressure: 72, Total Time: 01:18

Buttons: Name, Save, Save&Run, Delete, Cancel

## 4.6.1 Edit Recipe Cont.

29

**The Automated Pressure system enables you to set your pressure stages and their times to execute automatically.** The Dual Pressure system allows you to set the same stages and times, but as a guide to follow.

### 6: Weight

Set the weight of your material to have a repeatable bag fill and make yield calculations easier.

### 7: Bag Size

Set your bag size in order for the press to calculate pressure accurately.

### 8: Micron

Choose the ideal filter micron for your material.

### 9: Speed

Choose Fast, Medium, or Slow as a reference for your plate actuation speed, which is controlled manually with the speed dial.

### 1: Material

Flower, dry sift, or hash.

### 2: Stages 1 - 6

Air pressure and pressing time are set here, with up to six stages possible. Select the number of stages with the Stages box.

### 3: Name

Enter a reference name for your recipe. We recommend entering the strain as the recipe (and be sure to select the material type).

### 4: Save

Save your recipe as-is.

### 5: Save&Run

Saves and brings you to the Run Recipe screen to be used immediately.

The screenshot shows the 'Edit Recipe' screen with the following fields and buttons:

- 1: Material (NA)
- 2: Stages (1-6)
- 3: Name (Enter Name and add'l info...)
- 4: Save
- 5: Save&Run
- 6: Weight (g) (0.0)
- 7: Bag Size (NA)
- 8: Micron (NA)
- 9: Speed (NA)
- 10: Humidity (0%)
- 11: Heater1 (0)
- 12: Cancel
- 13: Delete

Material	Weight (g)	Bag Size	Micron	Speed	Humidity
NA	0.0	NA	NA	NA	0%

Stage#	1	2	3	4	5	6
Time	00:00	00:00	00:00	00:00	00:00	00:00
Pressure	0	0	0	0	0	0

Max Pressure: 0, Total Time: 00:00

Heater1	Heater2
0	0

Buttons: Name, Save, Save&Run, Delete, Cancel

### 10: Humidity

Set the relative humidity value of your material, if desired.

### 11: Heater 1 and 2

Set the top and bottom plate temperatures for your recipe.

### 12: Cancel

Exit the Edit Recipe menu and discard any changes you have made.

### 13: Delete

Erases and deletes your recipe permanently. Your settings will not be recoverable after deletion.

## 4.7 Preset Recipes

30

**With the Automated Pressure Control interface, you can select a material type and a bag size - the system will populate an automatic recipe that will do the rest.**

- Tap the “Material” button to select what you are planning to press. The available options are Flower, Kief, and Hash.
- Then, hit the “Bag Size” button to select which sized bag you intend to use.
- Once these two selections have been made, your press will automatically load an appropriate recipe that you can simply run.
- Once you run these recipes, you can then modify time, temperature, pressure, and so on to easily make your own special recipes with your material, via Last Run Data.

The screenshot shows the 'Edit Recipe' interface with the following details:

- Title:** Edit Recipe
- Subtitle:** Set Material Type then Bag Size
- Recipe Info:** Recipe Id: 0, Name: Preset
- Material:** Hash (selected)
- Weight (g):** 30.0
- Bag Size:** 2"x9" (selected)
- Micron:** 36 um
- Speed:** Slow
- Humidity:** 0%
- Stage#:** 1, 2, 3, 4, 5, 6
- Time:** 00:30, 00:15, 00:15, 00:30, 00:45, 00:45
- Pressure:** 5, 23, 26, 30, 44, 59
- Heater1:** 200
- Heater2:** 200
- Summary:** Max Pressure: 59, Total Time: 03:00
- Buttons:** Run, Cancel





## 4.8 Recipes (List)

31

**From the Recipes screen, all of your saved recipes are stored and catalogued.**

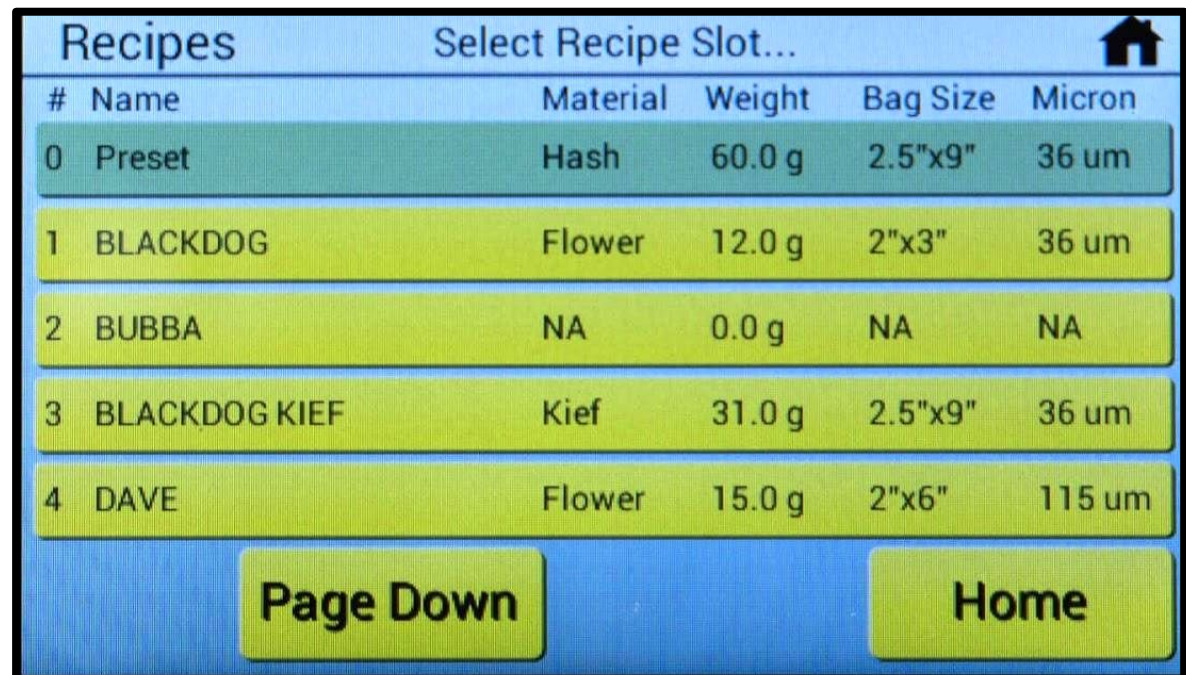
- Each page displays 5 recipes, including their name, material, weight, bag size, and micron type (if set).
- To access a specific recipe, simply tap the name to enter the “Edit Recipes” screen.
- There are a maximum of 29 total open recipe slots on both pressure systems.
- Any recipe that has been created and stored is available in this menu subset. Hit “Page Down” to scroll through all stored recipes.
- You can also return to the home screen from the “Recipes” list by hitting “Home”.



Recipes		Select Recipe Slot...				
#	Name	Material	Weight	Bag Size	Micron	
0	Preset	Hash	60.0 g	2.5"x9"	36 um	
1	BLACKDOG	Flower	12.0 g	2"x3"	36 um	
2	BUBBA	NA	0.0 g	NA	NA	
3	BLACKDOG KIEF	Kief	31.0 g	2.5"x9"	36 um	
4	DAVE	Flower	15.0 g	2"x6"	115 um	

Page Down Home

## 4.9 Run Recipe

32

**From the Run Recipes screen, you can automatically load any saved recipe to be used immediately.** There are two ways to run a recipe. First, you can load a recipe from the “Run Recipe” off of the home screen, or you can select the recipe you wish to use from the “Saved Recipes” list.

- By hitting the “Load Recipe” button underneath the “Air Pressure” toggle, you will be taken to the “Saved Recipes” list to choose the recipe you wish to run.
- From there, it will take you directly to the “Recipe” settings menu of your choice.
- Simply hit “Save&Run” at the bottom to load your recipe and begin using it.
- Ensure that your temperatures have stabilized and your input pressure from your air regulators is accurate before initiating your press. This helps ensure your recipe is executed correctly.

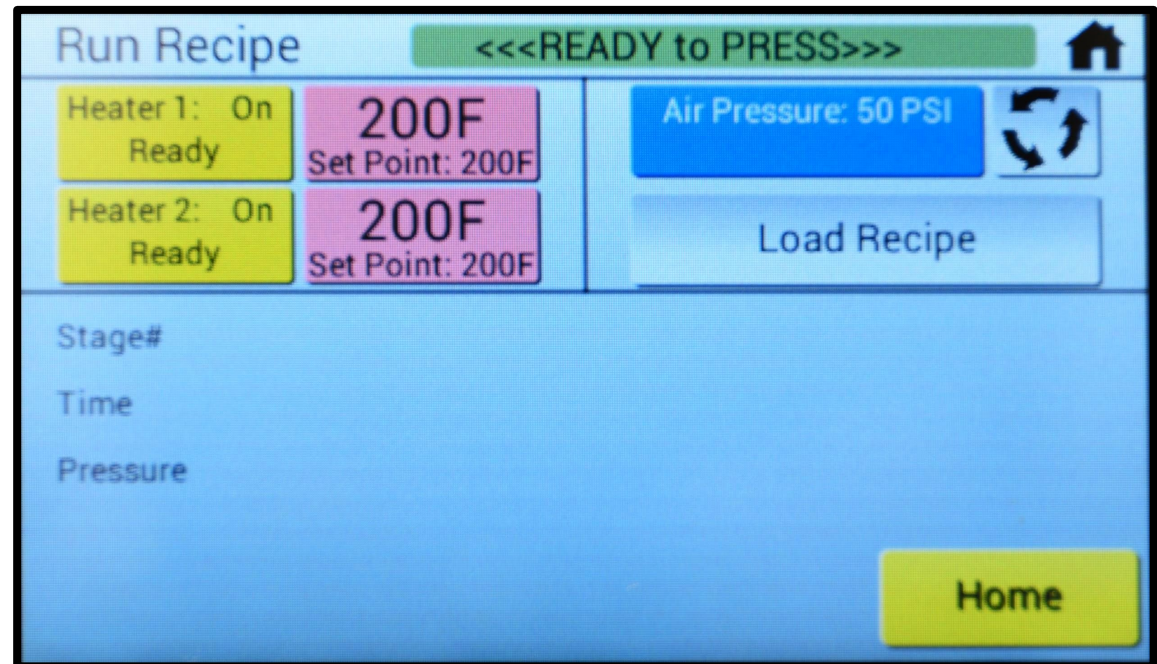

## 4.10 Pre-heat

33

**Note:** Your press will need at least 5 PSI to descend the plates but when stopped will not apply any force.

**The Pre-heat function is available only for Automated Pressure Control systems and enables you to warm up your bag while applying zero force.** This feature is especially helpful when pressing high quality ice water hash and sift, but is also useful for pressing flower too.

- Once you press the Pre-heat button it will highlight yellow, indicating it is enabled.
- Next, press your two start buttons, which will enable a slow descension of your plates.
- Simply release the two start buttons once your plates have made contact with your bag.
- Finally, once you are ready to apply force, tap the Pre-heat button once more (it will return to a grey color) and hold the two start buttons for 5 more seconds as you normally would to start your press cycle.

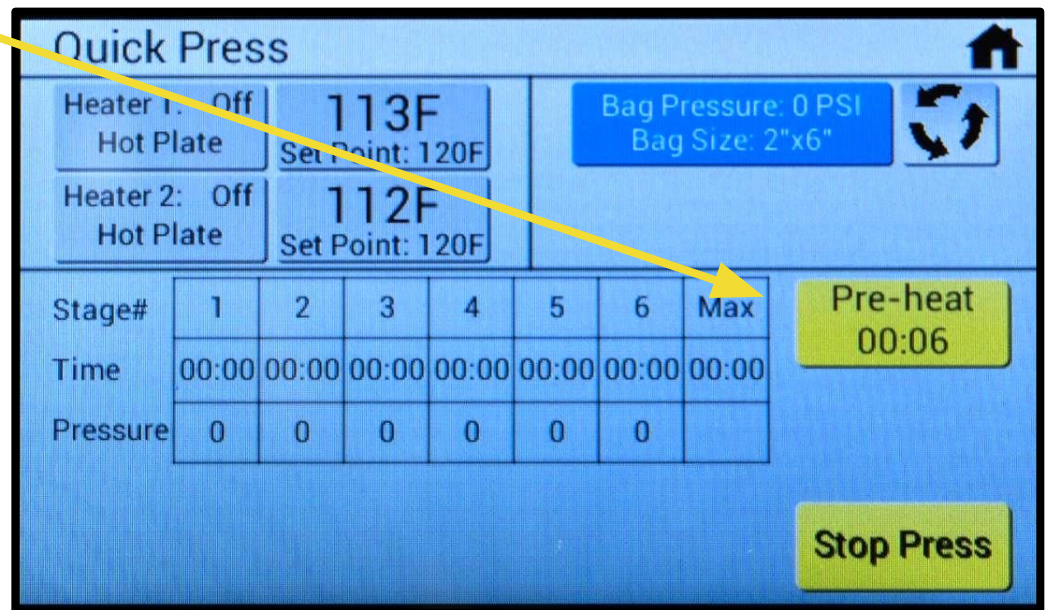



## 4.11 Software Updates

34

**With PurePressure's Pressware Connect software, you can always stay up to date with the latest version of our firmware.**

1. Using a T15 or T10 (depending on unit) torx screwdriver [star bit], remove the 11 screws and the top panel from your rosin press. **(Figure 1A)**
2. Set your screws and panel aside, and then locate the USB-B port on top of your electrical panel. **(Figure 2A)**
3. Using a USB-A to USB-B cable (also known as a standard printer cable), plug your press into a Windows or Mac computer and run the Pressware Connect application.
4. Whenever firmware updates are released, we will automatically email you the file that you need.
5. Next, visit [Downloads](https://gopurepressure.com/pages/downloads) (<https://gopurepressure.com/pages/downloads>) to download the appropriate files you will need. Make sure to select either the correct Windows or Mac file version depending on your computer.
6. Once downloaded, unzip and open the files contained within the firmware update folder. There will be step-by-step instructions included that are specific for either operating system to update your firmware to the latest version.

*Figure 1A*



*Figure 2A*

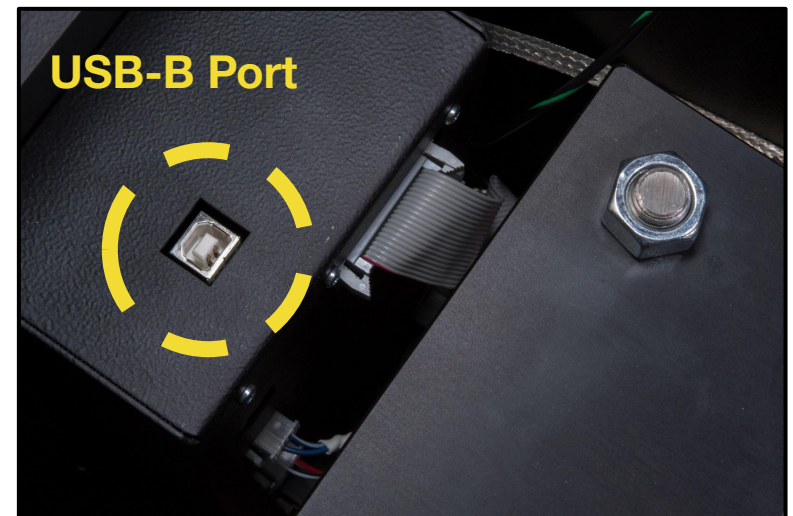

## 5. Press Operation

35

**Loading and operating your PurePressure rosin press is simple and intuitive.**

In the following sections, we will cover how to best operate your press.

### Basic Steps to Start Pressing

1. Turn your press on.
2. Set your desired temperature(s) and then turn on your top and bottom heaters.
3. Set your pressure with the air regulators.
4. Load your parchment into the front and rear parchment clips, and then your bag between the parchment.
5. Hit the two yellow buttons and start pressing!





## 5.1 Loading the Press

36

**Note:** We recommend using high quality nitrile gloves whenever you are working with rosin.

First, prepare your work area by having your pre-filled filter bags and parchment paper ready to go.

**WARNING: be mindful of your heated press plates!**

**Step 1:** Fold a 12" x 20" PurePressure sheet of parchment paper in half

- For vertical pressing, insert the folded end into the rear parchment clip.
- For horizontal pressing, insert the folded end into the front parchment clip.

**Step 2:** Tuck the unfilled end of your rosin bag underneath itself and then carefully insert and center your rosin filter bag on top of the lower bottom heat plate. **(Figure 1A)**

**Step 3:** Lastly, cover the rosin filter bag with the top parchment fold, re-center the bag, and while using tension on the parchment, insert the open parchment end into the parchment clip. **(Figure 2A)**

- For horizontal pressing, use tension on the parchment to close it properly so that your bag does not slip down beyond the edge of the heat plates.

Figure 1A



Figure 2A

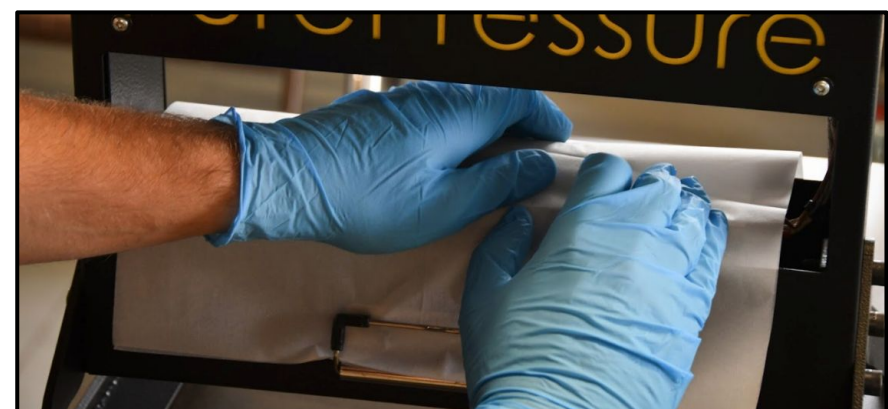

## 5.2 Automated Pressure Control

37

Check out this video for simple, visual instructions.

You Tube @GoPurePressure <http://bit.ly/DualPressureVid>

### How to Use the Automated Pressure System

#### Step 1: Ensure Your Air Pressure is Set to Maximum

Your press automatically comes set to the maximum recommended PSI, but using the Air Regulator cap you can adjust it up or down if necessary.

#### Recommended Regulator Settings

Pikes Peak: 120 PSI (set to maximum)  
Longs Peak: 140 PSI (set to maximum)

#### Step 2: Adjusting Your Pressure

You can adjust the pressure either in the [Quick Press](#) menu (described on slide 26) while pressing, or with the Air Pressure toggle screen, which is show here (**Figure 4**). You can set your force either in PSI or LBS, depending on your preference. Simply use the three arrow button next to the Air Pressure menu option to toggle your force selection.

Simply put in the pressure you wish you achieve and the system will do the rest. When you are doing a Quick Press, your Automated Pressure system will automatically record each pressure increase up to 6 stages so you can save that into a new recipe, which will increase in pressure just as you did.

**Note:** We recommend doing a few dry runs using the Automated Pressure system to get a hang of it before you do your first press.

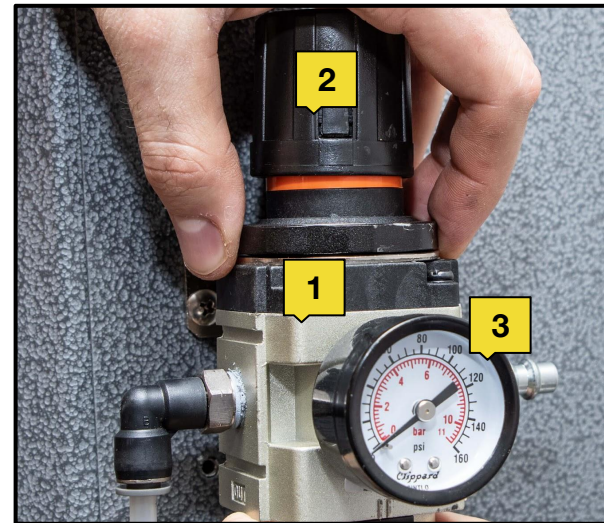

#### Components:

1. Air Regulator
2. Twist Cap
3. Pressure Gauge

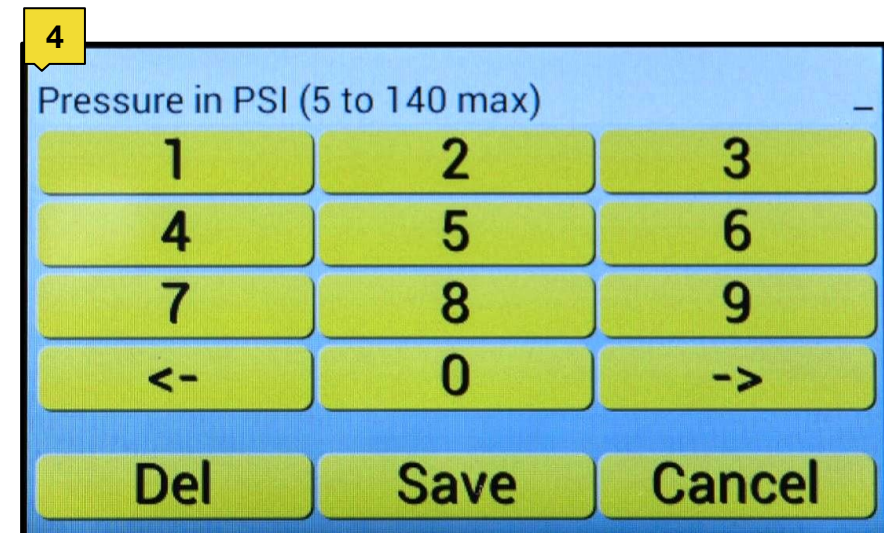

# 5.3 Dual Pressure Control

Check out this video for simple, visual instructions.

You Tube @GoPurePressure <http://bit.ly/DualPressureVid>

## How to Use the Dual Pressure System

### Step 1: Set Regulator Pressures

To adjust pressure, pull up on the air regulator caps so that the orange band is showing. Turn clockwise [right] to increase pressure, and counterclockwise [left] to decrease pressure.

**Note:** When decreasing pressure, it is important to go well below the set point and then increase pressure to your desired set point. If this is not performed as described, the pressure will drop as soon as air begins to flow through the regulator. You may then increase the pressure to your set point and it will stay steady.

### Recommended Regulator Settings

Pikes Peak **A:** 5 PSI, **B:** 120 PSI

Longs Peak **A:** 5 PSI, **B:** 140 PSI

**Note:** you must operate your **A** regulator as the low pressure regulator, and your **B** regulator as the high pressure regulator. If you reverse this, it will cause solenoid/air signal malfunction.

### Step 2: Using the Toggle Switch

The press will draw pressure from whichever regulator the toggle is positioned towards, and will hold pressure (air is trapped in the cylinder and applies a consistent pressing force) in the HOLD position (middle).

To increase pressure slowly, move the toggle to the middle position and then “bump” it to the right for approximately 1-2 seconds, and then return to the HOLD position. Repeat 2-3 times until you achieve the desired maximum pressure.

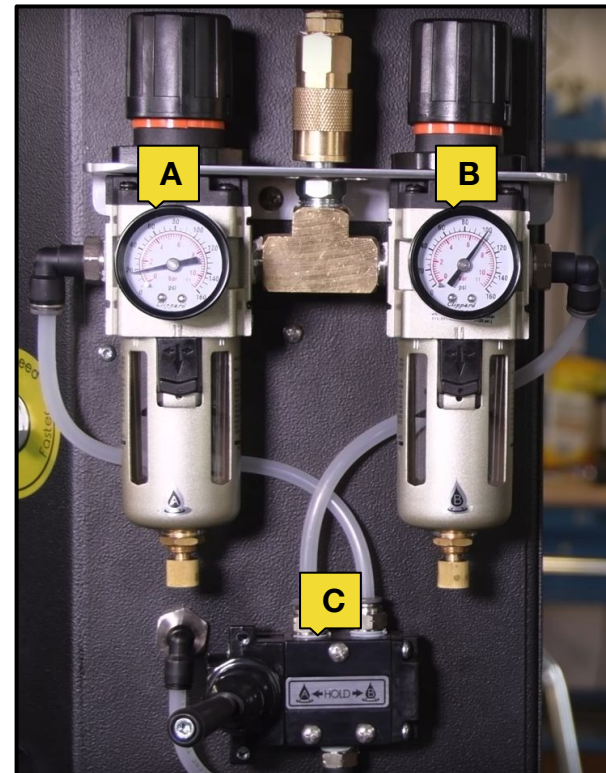

### Components:

1. **Regulator A**, used for low pressure [left]
2. **Regulator B**, used for high pressure [right]
3. **Pressure Toggle Switch**

**Note:** We recommend doing a few dry runs using the Dual Pressure system to get a hang of it before you do your first press.



## 5.4 Plate Speed Control

39

**Note:** Spend some time playing with the speed controller to get a hang of what the press is capable of.

**Controlling the actuation speed of your plates is helpful depending on what material you are pressing.**

To adjust your plate actuation speed, simply turn the dial clockwise [right] to decrease speed or counterclockwise [left] to increase speed.

The plate speed actuation knob acts as a flow controller which throttles the air that is exhausting from the opposite side of the piston in the air cylinder. This opposing air pressure is bled out at a rate controlled by the speed dial. This also means that the initial pressing forces is applied at that speed. This is useful to prevent bag blowouts when pressing kief, dry sift and bubble hash.

### Recommended Usage Speeds

- **Flower:** fast, fully threaded out
- **Kief and Hash:** slow, mostly threaded in



**Note:** If the plate speed controller is set too slow, the plates may not come into contact and may make a hissing sound.



## 5.5 Pressing Material

40

**Note:** Check out [Section 3](#) of this manual for top tips, tricks, and ideas to get the most out of your PurePressure rosin press.

### Now it's time to put it together and press!

Once you've filled, packed, and gotten your bag ready to press, set your temperatures on the press. We highly recommend using the preset recipes to begin pressing.

**Step 1:** Make sure your temperature and pressure settings are set.

**Step 2:** Load your bag between the parchment, ensuring it is properly centered. Then, secure both parchment clip ends closed.

**Step 3:** Enter the "Quick Press" menu or load the recipe you intend to use. You cannot operate the press from the "Home" screen.

**Step 4:** Hold the two yellow buttons for 5 seconds to initiate your press. If you release either button before then, the press will automatically retract the heat plates. There will be a countdown on the top.

**Step 5:** Once you see the oil flow slowing considerably or stopping, end your cycle by hitting "Stop Press" or letting the time expire on your pre-set recipe.



## 6. Maintenance & Troubleshooting

41

**Your PurePressure rosin press is engineered to go the distance. Make sure to do the following to ensure long term reliability.**

- ★ Use an adequately grounded power outlet or a surge protector.
- ★ Use clean, dry compressed air with your press.
- ★ Use your press indoors in a clean, low-dust room.
- ★ Use denatured alcohol or rubbing alcohol to quickly clean your heat plates when they are at room temperature with power disconnected.
- ★ If oil overflows onto the heater wires, turn the press off, remove the power cable, and carefully clean them with denatured alcohol or rubbing alcohol. Then, use some extra parchment to prevent it from happening in the future. Make sure the entire assembly is fully dry before powering your press back on.

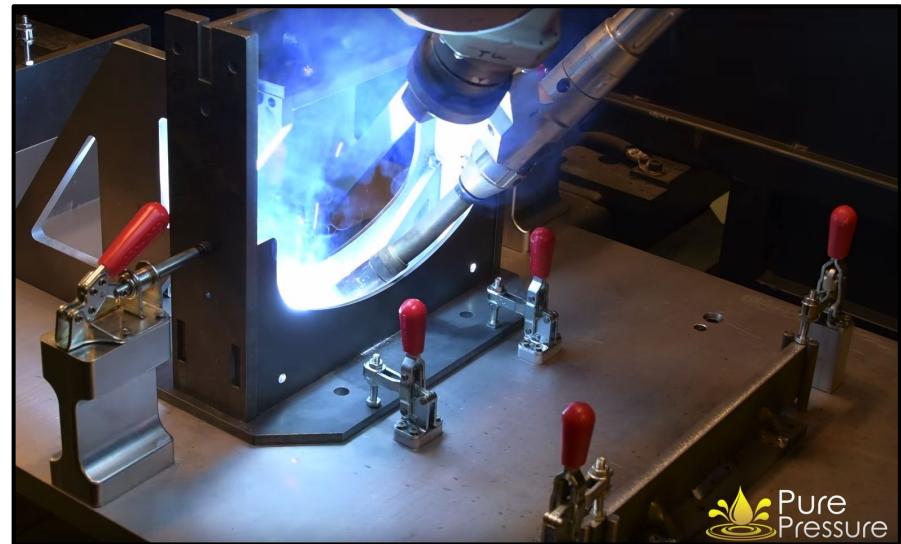

**If you encounter an issue with your press that is not described in the following pages, please contact us at [support@gopurepressure.com](mailto:support@gopurepressure.com)**

## 6.1 Common Issues

42

**Problem:** My plates won't fully make contact.

**Solution:** Make sure to turn your plate speed controller counterclockwise a few turns to open it up as it comes threaded all the way in for shipping.

**Problem:** My plates aren't retracting.

**Solution:** Make sure your pressure toggle switch is in the A or B position. If it is in the hold position, it will not be able to draw pressure to retract.

**Problem:** My pressure isn't getting high enough.

**Solution:** Make sure the output pressure of your air compressor is properly set. If your press is not receiving full, adequate pressure, your regulators will not be able to reach full pressure.

**Problem:** My flower isn't yielding well.

**Solution:** Material relative humidity impacts flower considerably - make sure your flower is properly humidified to at least 55% - 62%. We recommend using a humidor or a Boveda pack.

**Problem:** My bags are blowing out.

**Solution:** Make sure that you are starting at the minimum pressure and that your Plate Speed Controller is dialed nearly all the way in (clockwise) so that your plates meet very slowly. Ramp up your pressure even more slowly than you did before and ensure that oil is flowing before you continue to increase pressure.

Additionally, we recommend double bagging your kief and bubble hash until you determine safe pressure stages, and especially if you are pressing very high grade bubble hash. This is best done by having seams on opposite sides, and the folded-end of the first bag inserted downward into the second bag to ensure a fold on both ends as well. We often double bag a 36 micron inside of a 115 micron for the durability the 115 offers, while getting the filtration of the 36 micron.

If you are ever blowing out a bag with flower, it is probably because the bag is significantly over-packed causing a blowout.

## 6.2 Frequently Asked Questions

43

### What Micron Filter Bag Should I Use?

We typically recommend 36 $\mu$ m for kief and 115 $\mu$ m for flower or shake to start, but highly suggest experimenting with our 4 different micron types to see where you find your best results.

25 $\mu$ m/36 $\mu$ m/72 $\mu$ m: bubble hash, kief/dry sift  
90 $\mu$ m/115 $\mu$ m: flower, shake

### Do I Need to Use a Filter Bag?

Unless you are pressing just a few well-humidified buds, which you can certainly do without a bag, but otherwise, you will need to.

### At What Temperature Should I Press ?

For flower, most users find their best results between 200 °F and 220 °F. With kief or dry sift, most users find their best results between 190 °F and 220 °F. Finally, bubble hash, most users find their best results between 160 °F and 210 °F.

A higher temperature typically correlates to a higher yield, but it can also mean terpene loss. Similarly, at a lower temperature, quality tends to be higher but yields often decrease.

### What Pressure Should I Use?

For flower, use full pressure at a fast pressing speed. That means 120 PSI for the Pikes Peak and 140 PSI for the Longs Peak.

For kief and bubble hash, begin your press at the minimum pressure (10 PSI) and work up from there.

### How Much Should I Put in a Filter Bag?

Maximum Recommended Fill Amounts

- 2" x 3" Flower (6g) Kief/Bubble Hash (8g)
- 2" x 6" Flower (12g) Kief/Bubble Hash (16g)
- 2" x 9" Flower (18g) Kief/Bubble Hash (35g)
- 2.5" x 9" Flower (35g) Kief/Bubble Hash (70g)

### How Long Should I Press For?

A good rule of thumb is that the smaller your bag is, the less time you will need to press. Here are some general time ranges based on bag size:

- 2" x 3" :45 - 2:00
- 2" x 6" 1:00 - 3:00
- 2" x 9" 1:30 - 4:00
- 2.5" x 9" 2:00 - 5:00



## 6.3 Frequently Asked Questions cont.

44

### **How Do I Get a Lighter Colored Rosin?**

Use the freshest material possible. Freshness of material is critical to achieving clarity - the older it is, the darker it tends to be. The sooner after harvesting and drying the better, ideally within a week or two.

The other key factor involved in clarity is typically temperature. The hotter the temperature, the darker it may turn out, but only to a point. Find a balance between yield and temperature for optimal results.

### **What Yields Can I Expect?**

Material Yield Ranges

**Flower:** 15% - 30%

-Most commonly 18% - 24% with high quality material

**Kief / Dry Sift:** 30% - 60%

-Most commonly 40% - 50% with high quality material

**Bubble Hash:** 60% - 80%

-Most commonly 65% - 75% with high quality material

These yield ranges may vary and depend largely on the quality and age of your material.

### **What Strains Yield the Best?**

Highly resinous, trichome-rich, and high potency strains are always going to be your best yielders. These tend to skew more towards indicas and hybrids, but sometimes a sativa will surprise you!

### **Can I Press Trim?**

We do not recommend pressing just straight trim; you will get much better yields sifting your trim into kief first as opposed to just pressing it as-is.

### **What is the Best Starting Material?**

It is largely assumed that high quality bubble hash is the best starting material for making rosin. Ultimately, it really comes down to the quality of the starting material above all else. Ultra premium flower will typically create a better rosin than 3 or 4 star bubble hash, however 5 and 6 star bubble hash will make the highest value rosin.

### **Should I Use Dry Ice with My Sifter for Rosin?**

Using dry ice can lead to higher concentrations of undesired plant matter into your dry sift or kief. We recommend only using a small amount of pelletized dry ice (around the size of a grains of rice), or even better, not using dry ice at all, if possible.

## 6.4 Truss Service Instructions

45

### 6.4.1 Accuating Truss Alignment

The upper heat plate in the press is mounted to the actuating truss. The truss is driven by a clevis, which is threaded to the actuating rod of the cylinder. The threaded clevis will sometimes loosen causing the heat plates to misalign. This instance is rare, but there are a number of reasons this can happen during operation including conditions of use, material type or level of press usage. Follow the instructions below to service a misaligned truss.

#### Tools & Supplies:

- 1 1/8" Custom Flat Wrenches (by PurePressure, qty-2)
- T-15 Torx Driver
- Channel Locks
- Flathead Screwdriver
- 1/4" Allen Wrench
- 3/8" Allen Wrench
- Vise-Grip C Clamps w/ Rubber Jaws (qty 2)
  - A towel can also be used as a barrier to prevent damage to the plates when used.
- Small Wire Brush
- Zip Ties
- Denatured Alcohol
- Small Ruler or Tape Measure
- Loctite 243 Threadlocker

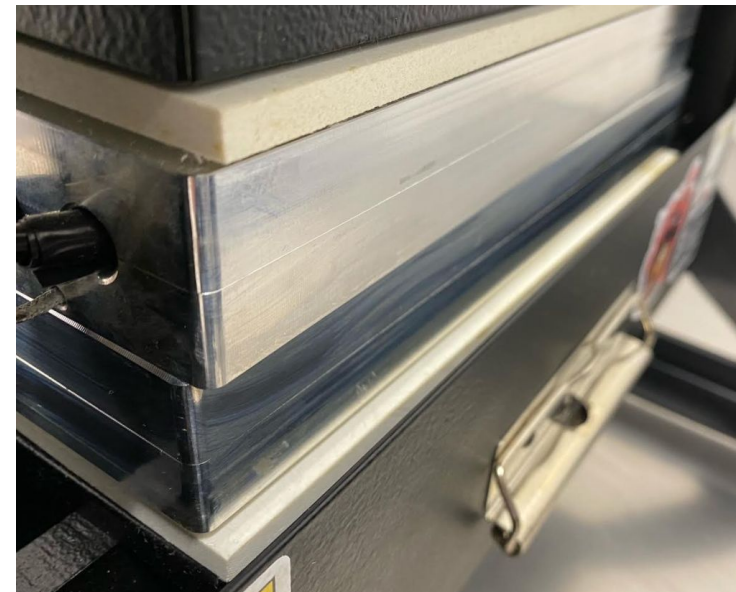

Here is an example of a misaligned accuating truss.

## 6.4.1 Actuating Truss Alignment Instructions

46

1. If the plates are compressed, then turn the press on and supply air to the regulator. This will cause the heat plates to separate.
2. POWER OFF the press and unplug from the power supply.
3. Remove the drip tray if you have one installed. It does not require hardware to remove and should lift right out from around the heaters.
4. Use two people to lay the press down on its back with the Vertical Legs hanging off the table, these legs will be getting removed.
5. Refer to the image on the next page for the following steps. Remove the vertical legs using a 1/4" Allen wrench to remove the hardware holding them on, there are 3 bolts per leg (Qty 6, 5/16-18 x 1-1/4" Bolt).
6. Also remove the smaller bolt on either side of the heater enclosure using a T-15 Torx Driver (Qty 2, #8-32x3/4" Bolt). Now slide off the Heater Enclosure.
7. Install the horizontal position legs. These are the legs that would have been shipped with the press for setting it up in a horizontal orientation.



## 6.4.2 Actuating Truss Alignment Instructions

47

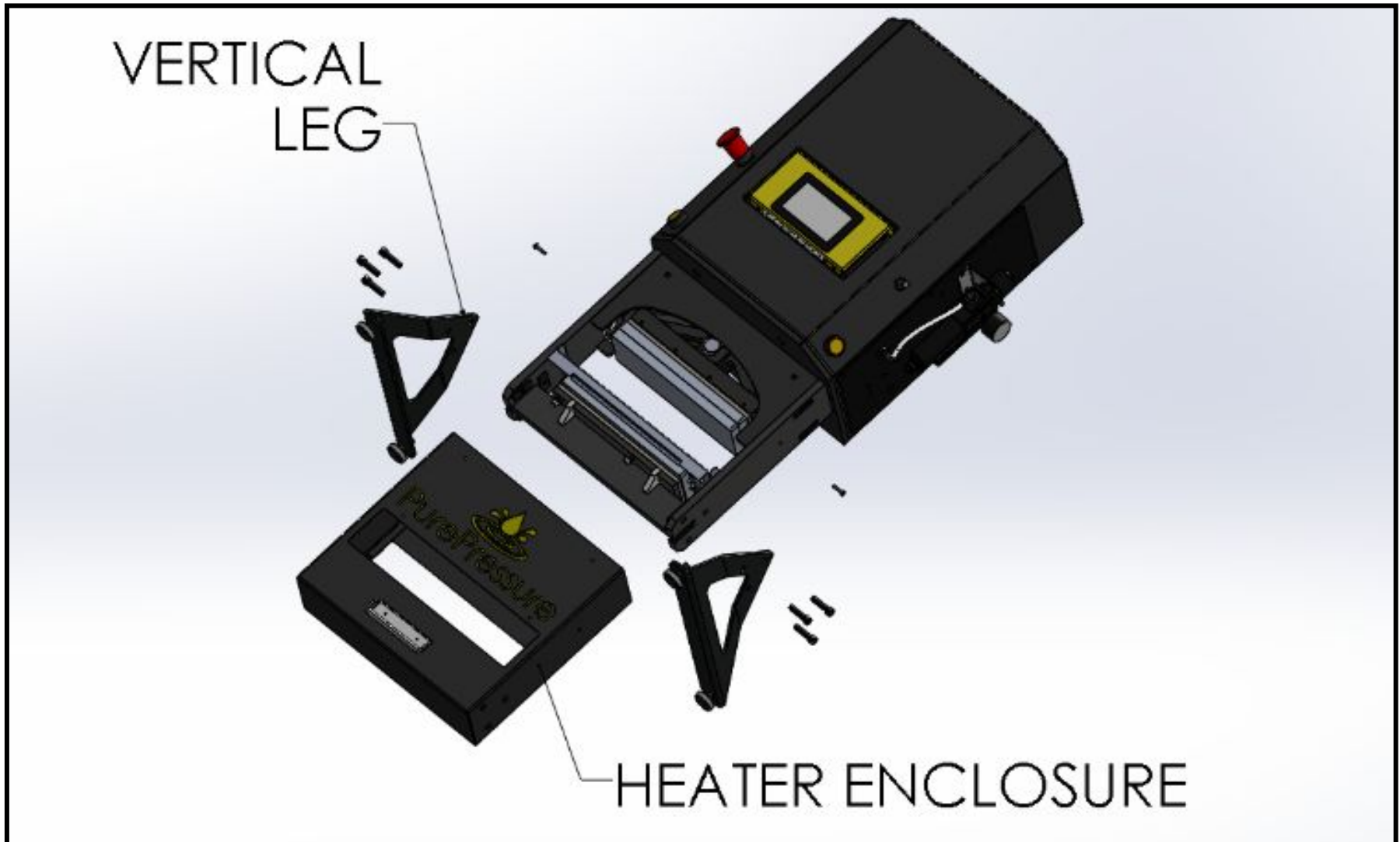



## 6.4.3 Actuating Truss Alignment Instructions

48

8. Place a towel over the assembly while doing this next step so you do not lose the c-clip. It will shoot off at the end of the removal. With the upper plate retracted, use a flathead screwdriver to remove the front visible C-Clip from the Clevis Pin. Do this by putting the flat head inside the opening between the C-Clip and Clevis Pin then twist the flat head. The part is meant to flex around the diameter of the shaft groove as it comes off. Only remove the C-Clip in front as shown. Once the c-clip is removed, the clevis pin should be able to fall out. Move the Upper Heat Plate assembly around to release the clevis pin if it does not come out freely.
9. Remove the zip ties shown in the image below. **DO NOT DISASSEMBLE THE UPPER HEAT PLATE ASSEMBLY.** It will still be tethered to the frame because of the heater cable leads.
10. Set the Upper Heat Plate assembly aside on something soft to the left side of the frame without stressing cable leads or scratching the surface of the heat plate.
11. Now we need to extend the Clevis toward the Lower Heat Plate. To do so power on and use the touchscreen, enter Quick Press and Hold the safety start buttons to begin a press. Next disconnect the air supply from your regulator, **POWER OFF** the press and unplug it from the power supply.

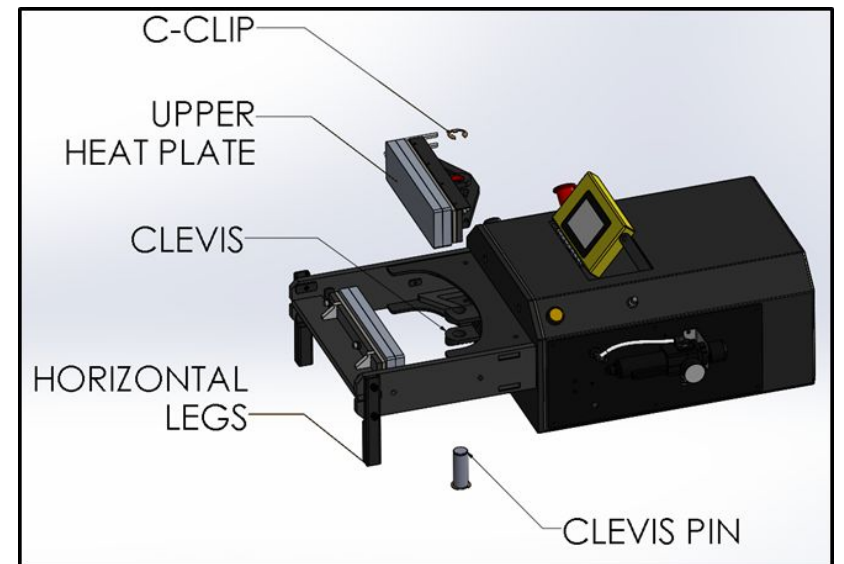
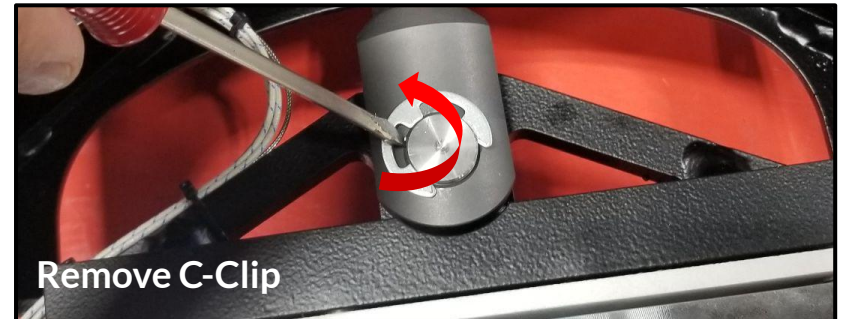

## 6.4.4 Actuating Truss Alignment Instructions

49

12. **Identify the Loose Joint(s)** - Begin by trying to loosen the Clevis by hand (turning counter clockwise). You may use channel locks on the Clevis body if needed for removal (do not damage the Clevis pin holes). Once you have removed the clevis, read through all 3 failure scenarios and follow the steps to to fix your press.

- a. **Scenario 1** - Only the Clevis has come loose from the Threaded Rod.

- i. Fully remove the Clevis and and then the 2 Jam Nuts. See step 13 for cleaning instructions.
- ii. Use ¼” allen wrench to test if the Threaded Rod is fixed inside the Piston Rod. So long as the Threaded Rod is fixed it is okay to proceed to Step 15 after cleaning.
- iii. If the Threaded Rod is moving freely inside the Piston Rod Proceed to Senario 3.

- b. **Scenario 2** - The Clevis and the Threaded Rod have come loose (with the jam nuts) from the female portion of the Piston Rod. However in this case the Clevis and Threaded Rod are still fixed together.

- iii. With the Threaded Rod fully removed from the Piston Rod you should be left with the Clevis, 2 Jam Nuts and the Threaded Rod all attached as an assembly. Remove the 2 Jam Nuts from the assembly using 1 ⅛” wrenches and/or the channel locks. PurePressure has these available for purchase.
- iv. Attempt to separate the Clevis and Threaded rod with tools. A ¼ in Allen Socket tool can be used with channel locks on the Clevis body. If they separate proceed to Senario 3.
- v. If the Clevis and Threaded Rod are fixed and cannot be separated, see step 13 for cleaning instructions.
- vi. Proceed with step 14a instructions after cleaning parts.

- c. **Senario 3** - The Clevis and Threaded Rod have broken free from each other and the Piston Rod.

- i. Fully remove the Threaded Rod from the Piston Rod. Disassemble the Jam Nuts and Clevis from the Threaded Rod. See step 13 for cleaning instructions.
- ii. Proceed with step 14b instructions after cleaning parts.

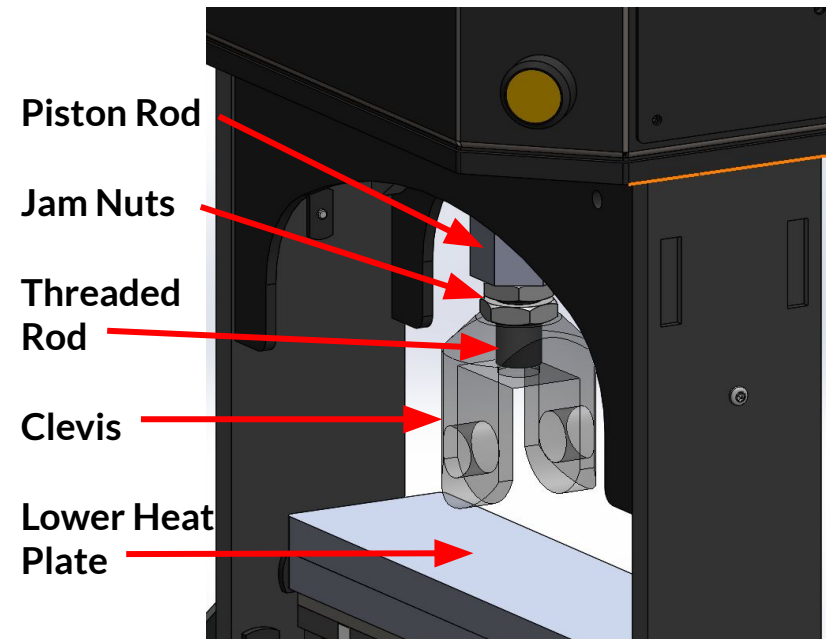

## 6.4.5 Actuating Truss Alignment Instructions

50

Note: Full cure time is 24 hours for Loctite 243 before you can operate the machine with heat.

13. **Cleaning and Part Preparation** - Once disassembled, all the hardware components to receive Loctite adhesive should be cleaned well with the wire brush and denatured alcohol. Use compressed air and a rag to remove all particulates from the thread valleys. Most of this will be old Loctite. It is critical to get all that off for a good adhesion with the new Loctite application.
  - a. Assembly Preparation - Steps after applying Loctite are time sensitive. When Loctite is applied to threads, the part should no longer be moved after 5 minutes. It is recommended you have the following tools available to complete the process so the Loctite compound is not compromised during the curing process.
  - b. Tools - 1/4in Allen Wrench, Flat Head Screwdriver, (qty2) 1 1/8in Flat Wrenches, (qty2) C-Clamps or Vise Grips.
  - c. Now is a good time to verify that your Clamps will work before proceeding. Refer to the 3rd image down on the next page.
14. **Threaded Rod Install** - Apply Loctite 243 to the threaded rod before installing. Apply all around the diameter. An excessive amount is not required, but make sure there is enough to fill the valleys of the threads. It is also extremely important to apply loctite to the inside female threads where the threaded rod is to be inserted.
  - a. Install the Jam nuts onto the Threaded Rod using Loctite. Thread both all the way against the Clevis and against one another. Do not torque the jam nuts with tools yet. Next install the Threaded Rod into the Rod Piston. Thread in all the way in until it reaches the jam nut, then back it out to face the Clevis Pin Hole as shown on the right. Continue to Step 15, you have 5 minutes to complete steps 15-20.
  - b. Apply Loctite as stated above when reinstalling each part. Insert the Threaded Rod into the Piston Rod first, and use a ruler to measure a 1.5" stick out. A minimum cure time of 45 minutes is required for the Loctite before proceeding. After waiting, install both Jam Nuts with loctite loosely hand-tighten both nuts against the Piston Rod. Do not torque the jam nuts with tools, proceed to step 15.

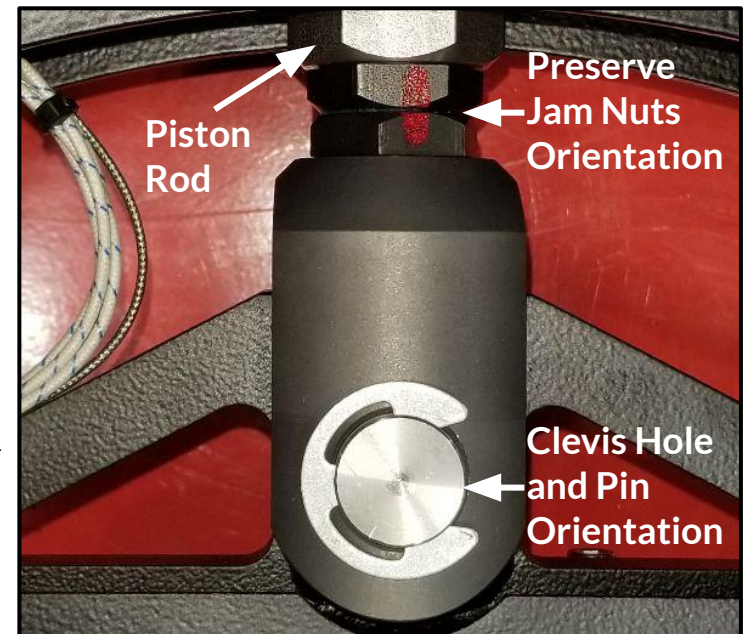
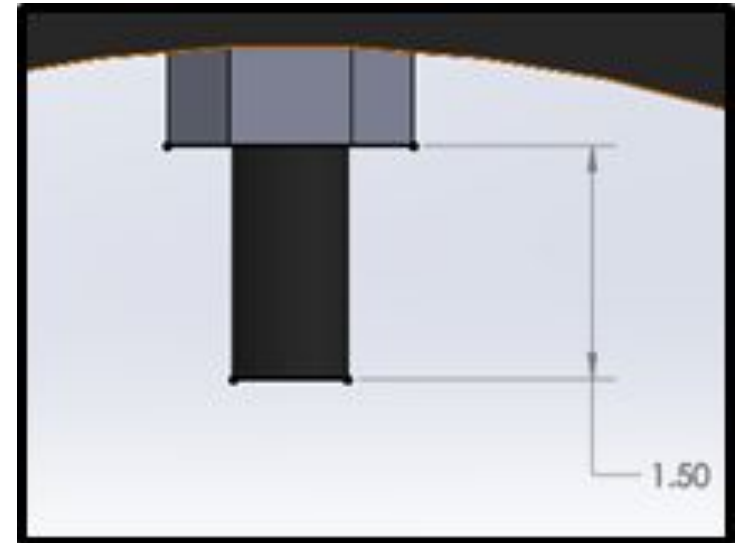



## 6.4.1.7 Actuating Truss Alignment Instructions

51

15. **Clevis Installation** - Install both Jam Nuts all the way against the Piston Rod first, use Loctite. Apply additional Loctite to the Threaded Rod and Clevis threads. Thread the Clevis onto the cylinder rod until it runs into the second jam nut then back it off until the clevis pin hole alignment faces the front of the machine.
16. **Make sure all hand and tools are clear from the press.** Connect air supply to the machine. This should retract the plates automatically moving them away from the lower (fixed) heat plate.
17. With the cylinder retracted, install the upper heat plate assembly with the clevis pin as it was before. The clevis pin should enter from the bottom so that the c-clip can be installed on top where it is easily accessible. Use a flat head to force the c-clip back onto the clevis pin.
18. On the touchscreen display enter Quick Press and Hold the safety start buttons until a press cycle begins. The heat plates should have contacted one another. Now disconnect the air supply from your regulator and power OFF the machine, the plates should remain compressed.
19. With the heat plates compressed use two Vise-Grip C Clamps with rubber jaws to align your upper and lower heat plate assemblies to one another.
20. Use the custom 1 1/8 inch flat wrenches to tighten the jam nuts. The upper jam nut should tighten against the hexagonal Piston Rod. The lower jam nut should tighten against the clevis. Allow the Loctite to cure for 24 hours before continuing to the next steps.

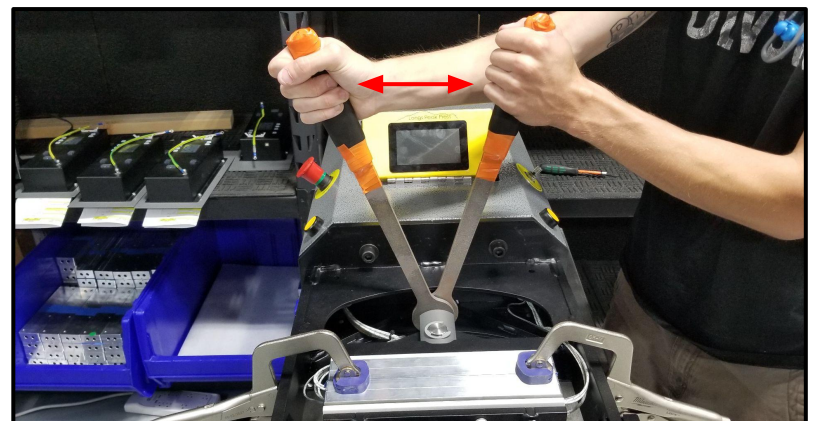
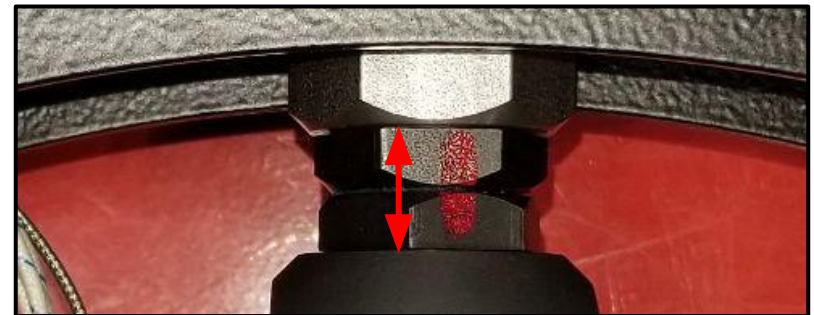
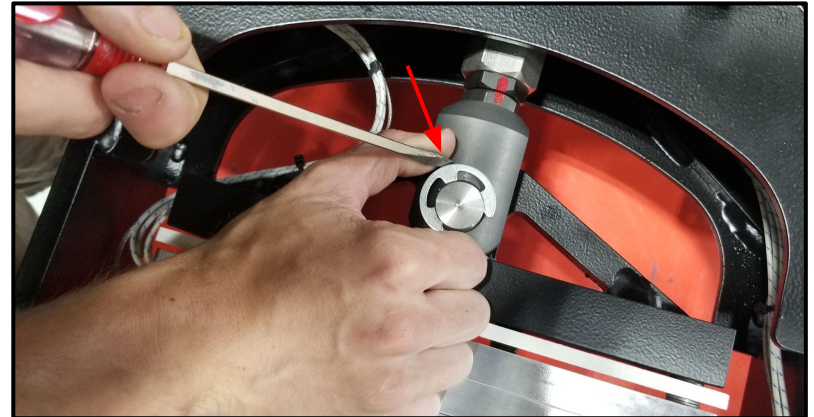



## 6.4.6 Actuating Truss Alignment Instructions

51

21. Now that the Loctite has cured for 24 hours remove the vise-grip c clamps. Connect air to your machine and the plates should immediately retract. **WATCH YOUR FINGERS, EXPOSED PINCH HAZARD WILL BE PRESENT.**
22. Reinstall the 2 zip ties that hold the upper heater cables in place.
23. Install the heater enclosure using the (qty2) smaller #8 bolts with a T-15 Torx driver.
24. Install the vertical legs with the (qty6) vertical leg bolts using a ¼" Allen wrench.
25. Use 2 people to stand the press back upright and begin running a few cycles to verify that the press is operating correctly.





 720-446-9565

 [purepressure.com](http://purepressure.com)

**Sales Inquiries:**

[sales@gopurepressure.com](mailto:sales@gopurepressure.com)

**General Questions:**

[info@gopurepressure.com](mailto:info@gopurepressure.com)

**Technical Support:**

[support@gopurepressure.com](mailto:support@gopurepressure.com)

   @gopurepressure

— **We're always here to help.**

---

User Manual R2.3